



IC-F9011 RadioG uide

November 2009



Your Smart P25 Choice



**P25T runking
P25Con ventional
AnalogCon ventional
ALLINONE**

Icom America Inc.

Foreword

This handbook provides detailed information about the IC-F9011 series VHF and UHF HANDHELD TRANSCEIVERS based on the latest firmware Rev.1.50.

Disclaimer

The information in this document has been carefully checked, and is believed to be correct and accurate. However, Icom assumes no responsibility for inaccuracies or mistakes. Furthermore, Icom reserves the right to make changes to any of the products described in this handbook without notice or obligation. The systems and applications described herein are for information and reference purposes only.

■ Handbook Revisions

Icom reserves the right to make changes to the content of this handbook at any time without notice or obligation.

■ IPR and Copyrights

The Icom products described in this handbook may include Icom Intellectual Property Rights (IPR) and/or copyrighted Icom computer programs stored in radio memories or other media/devices. Such IPR and copyrighted computer programs are protected by laws in Japan, the United States and other countries. Any Icom IPR and/or copyrighted Icom computer programs contained in the Icom products described in this manual may not be copied, reproduced, modified, reverse-engineered, or distributed in any way. Furthermore, the purchase of Icom products shall not be deemed to grant any license either directly or by implication, except for the normal non-exclusive license to use the product that is specified by law in the sale of a product.

■ Document Copyrights

No duplication or distribution of this document or any portion thereof shall take place without the express permission of Icom. Reproduction, distribution, or transmission for any purpose in any form or by any means, electronic or mechanical, shall only be allowed with the express permission of Icom.

■ Trademarks

Icom, Icom Inc. and the Icom logo are registered trademarks of Icom Incorporated (Japan) in the United States, the United Kingdom, Germany, France, Spain, Russia and/or other countries. AMBE+2™ is a trademark and property of Digital Voice Systems Inc. All other trademarks are the properties of their respective holders.

Microsoft, Windows and Windows Vista are either registered trademarks or trademarks of Microsoft Corporation in the United States and/or other countries.

Motorola and Astro are registered trademark of Motorola Corporation in the United States and/or other countries.

This product when used with certain options, utilizes vocoding technology that is the property of Digital Voice Systems Inc. The AMBE+2™ voice coding technology embodied in this product is protected by intellectual property rights including patent rights, copyrights and trade secrets of Digital Voice Systems, Inc. This voice coding technology is licensed solely for use within this Communications Equipment. The user of this technology is explicitly prohibited from attempting to extract, remove, decompile, reverse engineer, or disassemble the object Code, or in any other way convert the object code into a human-readable form. U.S. Patent Nos. #5,870,405, #5,826,222, #5,754,974, #5,701,390, #5,715,365, #5,649,050, #5,630,011, #5,581,656, #5,517,511, #5,491,772, #5,247,579, #5,226,084 and #5,195,166.

All other products or brands are registered trademarks or trademarks of their respective holders.

© 2008-2009 Icom Inc.

Table Of Contents

1	Introduction	
1-1	Company Profile	4
2	Over View	
2-1	Product Line Up	5
2-2	Common Features	6
2-3	IP Classification Codes	8
2-4	Project 25	9
2-5	Function and Specifications Comparison	10
3	Accessories	
3-1	Supplied Accessories Attachments	13
3-2	Optional Accessories	14
3-3	Optional Accessories Installation	
3-3-1	Battery/Battery Charging – Caution	16
3-3-2	Battery Charging	18
3-3-3	Battery Pack and Case	19
3-3-4	Speaker Microphone	20
3-3-5	Optional VS-1MC VOX/PTT Unit	21
3-3-6	Optional Internal Unit Installation	22
4	Operation and Function	
4-1	Operation and Function	
4-1-1	Operation and Function	24
4-1-2	Function Display [Simple/Full Keypad Model Only]	25
4-1-3	Functions Programmable to Keys	26
4-1-4	Preparation for Operation	29
4-1-5	Basic Operation	33
4-1-6	Analog Mode Operation	36
4-1-7	APCO P25 Mode Operation	37
4-1-8	APCO P25 Conventional & Trunking – Basic functions	52
4-1-9	Tactical Group Function	54
4-2	Cloning Software CS-F9010/F9510	
4-2-1	Basic Setup of Cloning Software	57
4-2-2	Cloning Items	60
4-2-3	APCO P25 Trunking – Cloning Software Setup	63
4-2-4	OTAR – Cloning Software Setup	68
4-3	APCO P25 Access Code Types	71
4-4	Scan	72
4-5	Display text	75
4-6	Voice Scrambling/Encryption	
4-6-1	Voice Scrambling/Encryption	76
4-6-2	Encryption Setup	77
4-7	OTAR	78
4-8	APCO P25 DVSI's AMBE+2™ Vocoder	79
	Appendix	
A-1	Promotional Materials	80
A-2	Useful Information on Icom America's Web site	81
A-3	Instruction Manual and Other Materials	83

Company Profile

Icom, the wireless communication experts

Icom Inc. is a company located in Osaka, Japan, and is a manufacturer of wireless communication products. Since Icom's establishment in 1954, we have had a long record as a trusted manufacturer of land mobile radio, amateur radio, marine radio, navigation products, aviation radio and communications receivers.

Quality & Reliability

Icom quality and Icom reliability

Over 50 years of engineering and production excellence is a part of every Icom product. Using the latest equipment, Icom radios are tested to pass rigorous in-house tests as well as environmental tests to the US Military standard 810 specifications. Icom holds ISO9001:2008 certification.

Production

Made in Japan quality

Icom is a rare example of an electronics manufacturer that has not shifted production to lower cost countries, but kept its production base 100% in Japan. The Wakayama Icom plant has an advanced production system to produce small volume/multi-model wireless communication products.

Icom brand

Icom, world brand name

Icom is today recognized as a reliable 2-way radio brand name around the world. Our land mobile radios are used by many professional organizations all over the world, like the United States Department of Defense and the U.S. Marine Corps. who chose Icom as the first Japanese company to supply radios to them.

Network

Icom's worldwide network

Icom's products are sold in over 80 countries in the World. Icom has an international sales and service network around the world, including sales subsidiaries in the US, Australia, Germany, Spain and liaison offices in France and China. Icom is here to support and service our products and your communication needs.



VHF Handheld Transceivers

IC-F901B/S/T (USA Version)

UHF Handheld Transceivers

IC-F9021B/S/T (USA Version)

IC-F9023B/S/T (EXP Version)



IC-F9011B
 “Non-display model”

IC-F9011S
 “Simple model”

IC-F9011T
 “10-key model”

Supplied Accessories
 (May differ according to version)



Dimensions (mm/inch)



APCO P25 DIGITAL RADIO SYSTEM – *Conventional and Trunking in one radio !*

APCO P25 Digital migration is now an inevitable trend for Federal, State and Local government users of 2-way radios. The IC-F9011 series, much more evolved from the IC-F70D series, is not simply enabling migration from analog to digital but also covers a wide range of features. The standard trunking capability of the IC-F9011 series is outstanding, ensuring smooth communication, despite busy signal traffic. Furthermore the IC-F9011 series has the advanced DVSI AMBE+2™ enhanced vocoder, resulting in clear speech audio.

APCO 25 [P25] Digital Features



❑ P25 Conventional and Trunking

The IC-F9011 series includes P25 conventional and trunking capabilities as standard. You can assign individual channels to conventional analog, conventional P25 or P25 trunking, all within one radio.

❑ Interoperability

The IC-F9011 series have passed CAP (Compatibility Assessment Program) and proved to provide interoperability with other brand P25 trunked infrastructure for public safety applications. The IC-F9011 series conforms to the standard specifications for TIA-102, CAAB-B, Digital C4FM Transceiver Performance recommendations.

❑ Digital/Analog mixed -mode operation

Mixed-mode operation allows you to detect and receive both analog FM and P25 digital modes and to transmit either mode depending on programming.

❑ Individual ID and talkgroup ID

The IC-F9011T/S and IC-F9021T/S have 100 individual ID and 250 talkgroup ID memories. Use the display to visually select the person or group you're going to call.

❑ Optional AES/DES encryption

The IC-F9011 series provides AES and/or DES encryption for secure conversation with the optional UT-125 AES/DES encryption unit or UT-128 DES encryption unit. Versions certified to FIPS 140-2 Level 1 for AES encryption are planned for future release.

❑ Enhanced vocoder ready

Using the DVSI's AMBE+2™ vocoder, the IC-F9011 series is enhanced vocoder ready.

❑ OTAR (Over-the-Air-Rekeying)

The IC-F9011 series supports P25 OTAR for changing encryption keys over the air.

❑ 4-way navigation cross keypad

The 4-way cross keypad* on the front panel provides an intuitive user interface.

* IC-F9011T/S and IC-F9021T/S only.



❑ Encryption button and 3-position zone select switch

On the top of the radio, there is a toggle switch to turn the encryption on or off* and the 3-position switch allows you to quickly select an operating zone*.

* According to the programming setting.



❑ Large dot-matrix display

The IC-F9011T/S and F9021T/S have a large dot-matrix display to show various operating controls at a glance.

At the bottom line of the display, the key indicator shows the functions assigned to the [I], [II] and [III] buttons for more efficient operation.



❑ Slim dimensions

At only 41.8mm (1 1/32 in) thick, the IC-F9011 series is designed to be a solid and ergonomic shape that will fit comfortably in your hand.



❑ 6W RF output power

The IC-F9011 series delivers 6W* of high output power. The supplied 3040mAh (typ.) Li-Ion battery pack, BP-254, provides 9 hours* of operating time.

* 5W for IC-F9021T/S/B. Typical operation with Tx: Rx: standby=5:5:90.

❑ **1000mW audio output power**

The built-in BTL amplifier doubles the audio output power and delivers loud audio to receive all calls under noisy environments. In addition, even when using an optional speaker microphone, the BTL amplifier output is also available from the external accessory connector which increases the audio output via the microphone.

❑ **IP57 dust and waterproof protection**

The IC-F9011 series features dust and waterproof protection equivalent to IP57 and is tested to demanding MIL-STD 810 requirements. IP57 waterproof protection means the IC-F9011 series can be submerged in 1 meter of water for 30 minutes. The radio can withstand rugged use even under harsh weather conditions.



❑ **14-pin accessory connector**

The new 14-pin accessory connector enhances the IC-F9011 series performance and capabilities. It has reserved pins for programmable key inputs.



❑ **Tactical group function**

The tactical group function allows you to copy memory channels to the tactical zone and temporarily regroup memory channels. Using the optional zone copy cable, memory channels in the tactical zone can be transferred from a master radio to other radios.

❑ **Abundant scanning settings**

The dual priority scan monitors two primary channels alternately, while scanning other channels. The mode-dependent scan function automatically changes the scan list according to the operating channel. The talk-back function with timer beep, TX channel and cancel channel settings allow you to preset the transmission channel when you push the PTT button during scanning operation or cancel scanning.

❑ **Optional Man Down unit**

With the optional Man Down unit, UT-124R, the IC-F9011 series automatically sends an emergency signal when the radio is left in a horizontal position for a preset time.

❑ **Other features**

- Wide frequency coverage (VHF : 136~174MHz UHF : 400~520MHz)
 - FM wide/narrow channel spacing*
 - 512 channels/128 zones
 - Built-in audio compander*
 - Built-in inversion type voice scrambler*
 - VOX function for hands-free operation
 - Optional waterproof speaker microphone, HM-184
 - Talk-around function
 - CTCSS and DTCS encoder and decoder*
 - DTMF autodial*
 - 2-Tone encoder and decoder* and MDC 1200 compatible* (Available in the future)
- *Analog mode only

❑ **Meets MIL-STD-810**

The MIL-STD-810 series of standards is issued by the United States Army's Developmental Test Command, to specify various environmental tests to prove that equipment qualified to the standard will survive in the field. Icom has been tested to and passed the following MIL-STD requirements and strict environmental standards.



Applicable U.S. Military Specifications

Standard	MIL 810F	
	Method	Procedure
Low Pressure	500.4	I, II
High Temperature	501.4	I, II
Low Temperature	502.4-3	I, II
Temperature Shock	503.4	I
Solar Radiation	505.4	I
Rain	506.4	I, III
Humidity	507.4	-
Salt Fog	509.4	-
Dust Blowing	510.4	I
Immersion	512.4	I
Vibration	514.5	I
Shock	516.5	I, IV







☒ Also meets equivalent MIL-STD-810-C, -D and -E.

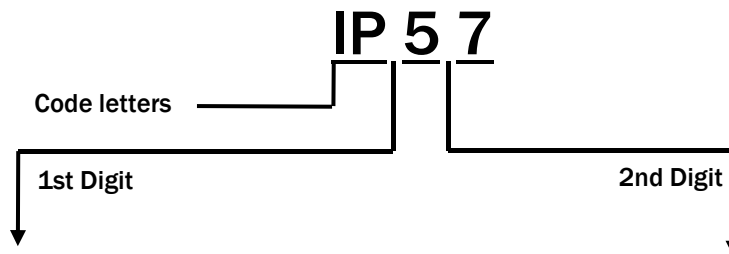





Ingress Protection (IP) ratings are developed by the European Committee for Electro Technical Standardization.

International Standard IEC 60529 outlines an international classification system that describes the sealing characteristics of electrical equipment. The classification system defines the level of protection provided by enclosures to prevent the ingress of foreign objects and moisture into the electrical equipment.

The classification system uses the “IP” code, or “Ingress Protection” code, to define the level of seal. An IP number contains two numbers (i.e. IP57) in most instances which relate to the level of protection provided by an enclosure or housing. Either number may be shown as “X” (i.e. IPX6 / IP7X) to indicate the “X” part is not tested.

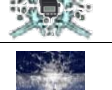

Degrees of Protection (Foreign Bodies) – 1st Digit	
IP Level	Description of Protection Level
0	Not protected
1	Protected against foreign solid objects of 50 mm diameter and greater (Protects against a large surface of the body, such as the back of a hand) 
2	Protected against foreign solid objects of 12.5 mm diameter and greater (Protects against fingers or similar objects) 
3	Protected against foreign solid objects of 2.5 mm diameter and greater (Protects against tools, thick wires, etc.) 
4	Protected against foreign solid objects of 1.0 mm diameter and greater (Protects against most wires, screws, etc.) 
5	Protected from the amount of dust that would interfere with normal operation 
6	Dust tight (No ingress of dust; complete protection against contact) 

Degrees of Protection (Moisture) – 2nd Digit	
IP Level	Description of Protection Level
0	Not protected
1	Protected against vertically falling water drops 
2	Protected against vertically falling water drops when enclosure is tilted up to 15° 
3	Protected against water sprayed at an angle up to 60° on either side of the vertical 
4	Protected against water splashed against the component from any direction 
5	Protected against water projected in jets from any direction 
6	Protected against water projected in powerful jets from any direction 
7	Protected against temporary immersion in water between 15cm and 1m for 30min. 
8	Protected against continuous immersion in water beyond 1m. 



What is Project 25?

Project 25 (P25) is a standard for the manufacturing of interoperable digital 2-way wireless communications products. Developed in North America under state, local and federal representatives and Telecommunications Industry Association (TIA) governance, P25 is gaining worldwide acceptance for public safety, security, public service, and commercial applications.

The published P25 standards suite is administered by the Telecommunications Industry Association (TIA Mobile and Personal Private Radio Standards Committee TR-8). Radio equipment that demonstrates compliance with P25 is able to meet a set of minimum requirements to fit the needs of public safety. These include the ability to interoperate with other P25 equipment, so that users on different systems can talk via direct radio contact. The P25 standard was created by and for public safety professionals.

What Are the Benefits of P25?

From the beginning, P25 has targeted four primary objectives:

- *Allow effective, efficient, and reliable intra-agency and inter-agency communications*

... so organizations can easily implement interoperable and seamless joint communication in both routine and emergency circumstances.

- *Ensure competition in system life cycle procurements*

... so agencies can choose from multiple vendors and products, ultimately saving money and gaining the freedom to select from the widest range of equipment and features.

- *Provide user-friendly equipment*

... so users can take full advantage of their radios' lifesaving capabilities on the job – even under adverse conditions – with minimal training.

- *Improve radio spectrum efficiency*

... so networks will have enough capacity to handle calls and allow room for growth, even in areas where the spectrum is crowded and it's difficult for agencies to obtain licenses for additional radio frequencies.

What is the Status of P25 Today?

P25 systems are available today and being deployed globally. Many organizations have mandated that new land mobile radio system purchases follow P25 standards. P25 is ongoing – the standard continues to evolve as the needs of users and the capabilities of new technology advance. Both users and manufacturers have an important role to play in shaping P25.

What is Required for P25 Compliance?

At a minimum, a P25 radio system must provide interoperability with these mandatory P25 Standard components:

- *The Common Air Interface (CAI) specifies how information is coded, transmitted and received over the air.*
It enables users to interoperate and communicate digitally across networks, agencies, and vendors.
- *The Improved Multi-Band Excitation (IMBE) vocoder converts speech into a digital bit stream.*
Test panels judged IMBE as the coding scheme most successful at making male and female voices audible against background noises such as moving vehicles, sirens, gunshots, and traffic noise – the conditions of public safety use. DVSI has introduced a new low data rate AMBE+2™ vocoder that sets a new standard for high-quality, high-performance speech quality at data rates from 2.0 to 9.6 kbps and Icom IC-F9011 series include this AMBE+2™ enhanced vocoder.

P25 has also defined standard modes of operation to enable multi-vendor interoperability for additional system functions: trunking, encryption, and over-the-air rekeying, to name a few.

A set of defined system interfaces allow the P25 system elements to communicate with host computers, data terminals and the public switched telephone network (PSTN).

Looking to the Future

There are two phases of P25 development:

- Phase 1 is completed.
It specifies a 12.5 kHz bandwidth.
- Phase 2 is in development.
It will use a 6.25 kHz equivalent bandwidth to allow better spectrum efficiency and benefit a greater number of users

2-5 Function and Specifications Comparison

Model No.	IC-F9011 B	IC-F9011S	IC-F9011T	IC-F9021B	IC-F9021B	
Version	#01	#05	#10	#01	#21	
Destinations	USA-01	USA-01	USA-01	USA-02	USA-03	
Keypad Model	No	Simple	Full	No	No	
Supplied Battery	BP-254 3040mAh	BP-254 3040mAh	BP-254 3040mAh	BP-254 3040mAh	BP-254 3040mAh	
Supplied Antenna	FA-S65V	FA-S65V	FA-S65V	FA-S58U	FA-S75U	
Type Approval	FCC	FCC	FCC	FCC	FCC	
FIPS 140-2 Certified *1 *3	-	-	-	-	-	
Intrinsically Safe	-	-	-	-	-	
Function Comparison						
CTCSS	✓	✓	✓	✓	✓	
DTCS	✓	✓	✓	✓	✓	
2-Tone *1	-	-	-	-	-	
5-Tone	-	-	-	-	-	
DTMF Autodial	✓	✓	✓	✓	✓	
DTMF Decoder	-	-	-	-	-	
MDC 1200 *1	-	-	-	-	-	
APCO P25 Digital Conventional	✓	✓	✓	✓	✓	
APCO P25 Digital Trunking	✓	✓	✓	✓	✓	
OTAR	✓	✓	✓	✓	✓	
SPECIFICATIONS - Measurements made in accordance with EIA-152-C/204D, TIA-603 B (analog).						
GENERAL	Frequency Range (MHz)		136-174		400~470 450~520	
	Number of Channels		512 ch / 128 zones			
	Channel Spacing (kHz)		12.5 (digital), 15/30 (analog)		12.5 (digital), 12.5/25 (analog)	
	PLL Channel Step (Unit: kHz)		2.5 / 3.125			
	Current drain	Tx	High	2.2A		2.1A
		Rx	Stand-by	300mA		300mA
			Max. audio	800mA		800mA
	Operating Time *2		9 hours (with BP-254)			
	Dimensions (W × H × D) (projections not included)		58.6 × 167 × 41.8 mm 2 ⁵ / ₁₆ × 6 ⁹ / ₁₆ × 1 ²¹ / ₃₂ in			
	Weight (approx.)		533g; 1.17lb (with BP-254)			
TX	RF Output Power (High)		6W		5W	
	Spurious Emissions		78dB (typ.)		80dB (typ.)	
	Adjacent Channel Power (W/N)		70/60dB (min.,analog), 67dB (min.,digital)			
RX	Sensitivity (at 12dB SiNAD)		0.25µV (typ., analog) 0.30µV (typ.,digital)			
	Adjacent Channel Selectivity (W/M) FM(Analog), Digital(P25)		FM80/70dB (typ.), P25 60dB (typ.)		FM76/70dB (typ.), P25 60dB (typ.)	
	Spurious Response Rejection		80dB (typ.)			
	Intermodulation Rejection		75dB (typ.)			
	AF Output Power (at 5% distortion with an 8Ω load)		1000mW (typ.)			

*1. Planned to be available in the future

*2 . Operating time is approximate time (at 20°C). Tx: Rx: standby=5:5:90. Power save on.

*3. Depending on version.

Function and Specifications Comparison

Model No.	IC-F9021S	IC-F9021S	IC-F9021T	IC-F9021T	IC-F9023B		
Version	#05	#25	#10	#30	#02		
Destinations	USA-02	USA-03	USA-02	USA-03	EXP-02		
Keypad Model	Simple	Simple	Full	Full	No		
Supplied Battery	BP-254 3040mAh	BP-254 3040mAh	BP-254 3040mAh	BP-254 3040mAh	BP-254 3040mAh		
Supplied Antenna	FA-S58U	FA-S75U	FA-S58U	FA-S75U	FA-S58U		
Type Approval	FCC	FCC	FCC	FCC	-		
FIPS 140-2 Certified *1 *3	-	-	-	-	-		
Intrinsically Safe	-	-	-	-	-		
Function Comparison							
CTCSS	✓	✓	✓	✓	✓		
DTCS	✓	✓	✓	✓	✓		
2-Tone *1	-	-	-	-	-		
5-Tone	-	-	-	-	-		
DTMF Autodial	✓	✓	✓	✓	✓		
DTMF Decoder	-	-	-	-	-		
MDC 1200 *1	-	-	-	-	-		
APCO P25 Digital Conventional	✓	✓	✓	✓	✓		
APCO P25 Digital Trunking	✓	✓	✓	✓	✓		
OTAR	✓	✓	✓	✓	✓		
SPECIFICATIONS - Measurements made in accordance with EIA-152-C/204D, TIA-603 B (analog).							
GENERAL	Frequency Range (MHz)	400 ~ 470	450 ~ 520	400 ~ 470	450 ~ 520	400 ~ 470	
	Number of Channels	512 ch/128 zones					
	Channel Spacing (kHz)	12.5 (digital) / 12.5/25 (analog)					
	PLL Channel Step (Unit: kHz)	2.5 / 3.125					
	Current Drain	Tx	High				2.1A
		Rx	Stand-by				300mA
			Max. audio				800mA
	Operating Time *2	9 hours (with BP-254)					
	Dimensions (W × H × D) (projections not included)	58.6 × 167 × 41.8 mm 2 ⁵ / ₁₆ × 6 ⁹ / ₁₆ × 1 ²¹ / ₃₂ in					
	Weight (approx.)	533g; 1.17lb (with BP-254)					
TX	RF Output Power (High)	5W					
	Spurious Emissions	80dB (typ.)					
	Adjacent Channel Power (W/N)	70/60dB (min.,analog) 67 dB (min.,digital)					
RX	Sensitivity (at 12dB SINAD)	0.25μV (typ., analog) 0.30μV (typ.,digital)					
	Adjacent Channel Selectivity (W/M) FM(Analog), P25(Digital)	FM76/70 dB (typ.) P25 60 dB (typ.)					
	Spurious Response Rejection	80dB (typ.)					
	Intermodulation Rejection	75dB (typ.)					
	AF Output Power (at 5% distortion with an 8Ω load)	1000mW (typ.)					

*1. Planned to be available in the future

*2. Operating time is approximate time (at 20°C). Tx: Rx: standby=5:5:90. Power save on.

*3. Depending on version.

NOTE: The UHF IC-F9021S/B/T series that covers frequency range from 380 to 450 MHz is planned to be released in the future.

Function and Specifications Comparison

Model No.	IC-F9023S	IC-F9023S	IC-F9023T	IC-F9023T		
Version	#06	#26	#11	#31		
Destinations	EXP-02	EXP-03	EXP-02	EXP-03		
Keypad Model	Simple	Simple	Full	Full		
Supplied Battery	BP-254 3040mAh	BP-254 3040mAh	BP-254 3040mAh	BP-254 3040mAh		
Supplied Antenna	FA-S58U	FA-S75U	FA-S58U	FA-S75U		
Type Approval	-	-	-	-		
FIPS 140-2 Certified *1 *3	-	-	-	-		
Intrinsically Safe	-	-	-	-		
Function Comparison						
CTCSS	✓	✓	✓	✓		
DTCS	✓	✓	✓	✓		
2-Tone *1	-	-	-	-		
5-Tone	-	-	-	-		
DTMF Autodial	✓	✓	✓	✓		
DTMF Decoder	-	-	-	-		
MDC 1200 *1	-	-	-	-		
APCO P25 Digital Conventional	✓	✓	✓	✓		
APCO P25 Digital Trunking	✓	✓	✓	✓		
OTAR	✓	✓	✓	✓		
SPECIFICATIONS - Measurements made in accordance with EIA-152-C/204D, TIA-603 (analog).						
GENERAL	Frequency Range (MHz)	400~470	450~520	400~470	450~520	
	Number of Channels	512 ch / 128 zones				
	Channel Spacing (kHz)	12.5 (digital) / 12.5/25 (analog)				
	PLL Channel Step (Unit: kHz)	2.5 / 3.125				
	Current drain	Tx	High	2.1A		
			Stand-by	300mA		
		Rx	Max. audio	800mA		
	Operating Time *3	9 hours (with BP-254)				
	Dimensions (W × H × D) (projections not included)	58.6 × 167 × 41.8 mm 2 ⁵ / ₁₆ × 6 ⁹ / ₁₆ × 1 ²¹ / ₃₂ in				
	Weight (approx.)	533g; 1.17lb (with BP-254)				
TX	RF Output Power (High)	5W				
	Spurious Emissions	80dB (typ.)				
	Adjacent Channel Power (W/N) FM (Analog), P25(Digital)	70/60dB (min.,analog) 67 dB (min.,digital)				
RX	Sensitivity (at 12dB SINAD)	0.25μV (typ., analog) 0.30μV (typ.,digital)				
	Adjacent Channel Selectivity (W/M)	FM76/70 dB (typ.) P25 60 dB (typ.)				
	Spurious Response Rejection	80dB (typ.)				
	Intermodulation Rejection	75dB (typ.)				
	AF Output Power (at 5% distortion with an 8Ω load)	1000mW (typ.)				

*1. Planned to be available in the future

*2. Operating time is approximate time (at 20°C). Tx: Rx: standby=5:5:90. Power save on.

*3. Depending on version.

Attach the supplied accessories as shown below.

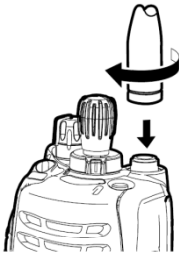

◇ Flexible antenna

Connect the supplied flexible antenna to the antenna connector.

CAUTION:

- NEVER carry the transceiver by holding the antenna.
- DO NOT connect the antenna other than those listed on 3-3-6 Other Options.
- Transmitting without an antenna may damage the transceiver.

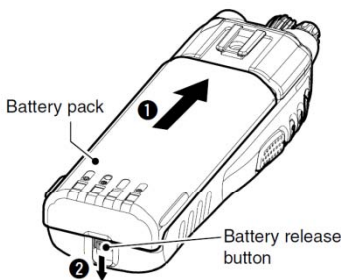

◇ Battery pack

To attach the battery pack:

Slide the battery pack on the back of the transceiver in the direction of the arrow (1), then lock it with the battery release button.

- Slide the battery pack until the battery release button makes a 'click' sound.

To release the battery pack:

Slide the battery release button in the direction of the arrow (2) as shown below. The battery pack is then released.

NEVER release or attach the battery pack when the transceiver is wet or soiled. This may result water or dust access to the transceiver/battery pack and may result in the transceiver being damaged.

NOTE: Keep the battery pack terminals clean. It's a good idea to clean the battery pack terminals once a week.

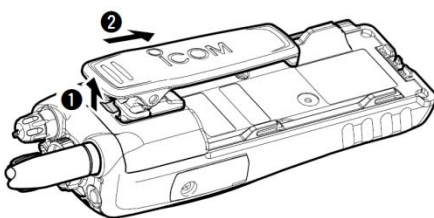
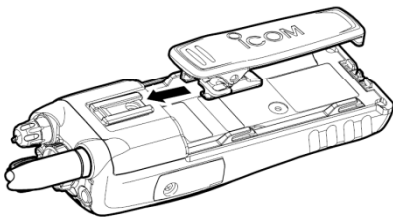

◇ Belt clip

To attach the belt clip:

- 1 Release the battery pack if it is attached.
- 2 Slide the belt clip in the direction of the arrow until the belt clip is locked and makes a 'click' sound.

To detach the belt clip:

- 1 Release the battery pack if it is attached.
- 2 Pinch the clip (1), and slide the belt clip in the direction of the arrow (2).

◇ Connector cover

Attach the connector cover when optional equipment is not used.

To attach the connector cover:

- 1 Insert the connector cover into the multi-connector.
- 2 Tighten the screw, using a Philips screwdriver.

CAUTION:

Attach the connector cover when the optional equipment is not used. Otherwise the terminals of the multi-connector may be shorted by metal objects, etc., and this could damage the transceiver.

To detach the connector cover:

- 1 Unscrew the screw, using a Phillips screwdriver.
 - 2 Detach the connector cover for the optional equipment connector.
- Connector cover.

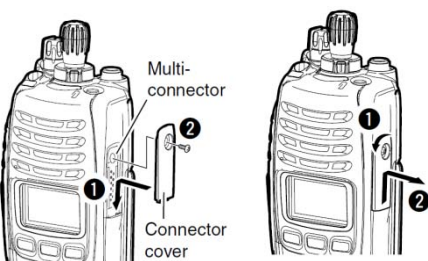

3-2 Optional Accessories

The optional accessories available with IC-F9011 series is shown below. Ask your Icom distributor for further details if required. (Some options may not be available for all countries.)

*BATTERY PACKS and CASE		*DESKTOP CHARGER		
 BP-254 Li-Ion BATTERY PACK, 7.4V/3040mAh 2900mAh(min) 3040mAh(typ)	 BP-237 BATTERY CASE AA (LR6)x6 alkaline cells. Water-resistant equivalent to IPX4	 ▲ BC-119N	 ▲ AD-110	 ▲ BC-145SA
BC-119N DESKTOP CHARGER + AD-110 CHARGER ADAPTER + BC-145SA AC ADAPTER Rapidly charges the BP-253 or BP-254. Charging time: approx. 4.0 hours when BP-253 is attached.				
MULTI-CHARGER		ZONE COPY CABLES		Connector
 ▲ BC-121N	 ▲ AD-110 (6 pcs).	 ▲ BC-157	 OPC-1870 Handheld to handheld CABLE	 OPC-1871 Handheld to mobile CABLE
BC-121N MULTI-CHARGER + AD-110 CHARGER ADAPTER + BC-157 AC ADAPTER Rapidly charges up to 6 battery packs (Six AD-110s are required). Charging time: approx.4.0 hours when BP-253 is attached.		5610000270 ALA651B 8 pin connector for modular plugs (use with Key Loader cables)		
POWER SUPPLY CABLES		INTERFACE CABLE		KEYLOADER CABLE
 CP-23L CIGARETTE LIGHTER CABLE For use with BC-119N	 OPC-515L DC POWER CABLE For use with BC-119N.	 OPC-656 DC POWER CABLE For use with BC-121N.	 OPC-1862	 OPC-1637 
OPC-1862 PC (USB) INTERFACE CABLE/CLONE CABLE packed with OPC-1637 and USB driver CD.		OPC-1534 KEYLOADER CABLE to KVL 3000 PLUS to install encryption keys (Must be used with OPC-1871)		

*Refer to the "3-3 OPTIONAL ACCESSORIES INSTALLATION" section of this handbook.

ANTENNAS		CUT ANTENNA		BELT CLIP
				
<p>FA-S25V : 136-148MHz FA-S65V : 148-160MHz FA-S66V : 160-174MHz</p>		<p>FA-S30U : 380-430MHz FA-S58U : 430-470MHz FA-S75U : 470-520MHz</p>		<p>FA-S67VC : 136-174MHz FA-S76UC : 380-520MHz</p>
<p>MB-115 : Alligator model to fit up to 60mm (2 3/8 Inch) width belt. Same as supplied.</p>				
HEADSETS and PTT/VOX UNIT				
				
<p>HS-94 : Earhook headset with flexible boom microphone. Approved option for intrinsically safe versions.</p>		<p>HS-95 : Behind-the-head headset with flexible boom microphone. Approved option for intrinsically safe versions.</p>		<p>HS-97 : Throat microphone fits around the neck and picks up speech vibration. Approved option for intrinsically safe versions.</p>
<p> *VS-1MC : PTT/VOX unit. Required when using these headsets with the transceiver. Approved option for intrinsically safe versions.</p>				
<p> The pictures of headset shown above include optional VS-1MC PTT/VOX unit.</p>				
*SPEAKER-MIC	*INTERNAL UNITS			CLONING SOFTWARE
				<p>CS-F9511 EXP #01: For programming all versions of the IC-F9011/F9023 series VHF/UHF HANDHELD TRANSCEIVERS.</p>
<p>HM-184 : Rugged model speaker-microphone. Equivalent to IP57.</p>	<p>UT-124 R MAN DOWN UNIT : Automatically sends an emergency signal when the transceiver is left in a horizontal for a preset time</p>	<p>UT-125 AES/DES ENCRYPTION UNIT Provides AES and DES encryption capabilities</p>	<p>UT-128 DES ENCRYPTION UNIT Provides DES encryption capabilities</p>	

*Refer to the "3-3 OPTIONAL ACCESSORIES INSTALLATION" section of this handbook.

■ Caution

Misuse of Lithium-Ion batteries may result in the following hazards: smoke, fire, or the battery may rupture. Misuse can also cause damage to the battery or degradation of battery performance.

DANGER! ⚠ Use and charge only specified Icom battery packs with Icom radios or Icom chargers. Only Icom battery packs are tested and approved for use and charge with Icom radios or Icom chargers. Using third-party or counterfeit battery packs or chargers may cause smoke, fire, or cause the battery to burst.

◇ Battery caution

- ⚠ **DANGER!** DO NOT hammer or otherwise impact the battery. Do not use the battery if it has been severely impacted or dropped, or if the battery has been subjected to heavy pressure. Battery damage may not be visible on the outside of the case. Even if the surface of the battery does not show cracks or any other damage, the cells inside the battery may rupture or catch fire.
- ⚠ **DANGER!** NEVER use or leave battery packs in areas with temperatures above +60 °C (+140 °F). High temperature buildup in the battery, such as could occur near fires or stoves, inside a car heated car, or in direct sunlight may cause the battery to rupture or catch fire. Excessive temperatures may also degrade battery performance or shorten battery life.
- ⚠ **DANGER!** DO NOT expose the battery to rain, snow, seawater, or any other liquids. Never charge or use a wet battery. If the battery gets wet, be sure to wipe it dry before using.
- ⚠ **DANGER!** NEVER incinerate used battery packs since internal battery gas may cause them to rupture, or may cause an explosion.
- ⚠ **DANGER!** NEVER solder the battery terminals and NEVER modify the battery pack. This may cause heat generation, and the battery may rupture, emit smoke or catch fire.
- ⚠ **DANGER!** Use the battery only with the transceiver for which it is specified. Never use a battery with any other equipment, or for any purpose that is not specified in this instruction manual.

- **DANGER!** If fluid from inside the battery gets in your eyes, blindness can result. Rinse your eyes with clean water, without rubbing them, and see a doctor immediately.
- **WARNING!** Immediately stop using the battery if it emits an abnormal odor, heats up, or is discolored or deformed. If any of these conditions occur, contact your Icom dealer or distributor.
- **WARNING!** Immediately wash, using clean water, any part of the body that comes into contact with fluid from inside the battery.
- **WARNING!** NEVER put the battery in a microwave oven, high-pressure container, or in an induction heating cooker. This could cause a fire, overheating, or cause the battery to rupture.
- **CAUTION!** Always use the battery within the specified temperature range for the transceiver (-30 °C to +60 °C; -22 °F to +140 °F) and the battery itself (-20 °C to +60 °C; -4 °F to +140 °F). Using the battery out of its specified temperature range will reduce the battery's performance and battery life.
- **CAUTION!** Shorter battery life could occur if the battery is left fully charged, completely discharged, or in an excessive temperature environment (above +45 °C; +113 °F) for an extended period of time. If the battery must be left unused for a long time, it must be detached from the radio after discharging. You may use the battery until the remaining capacity is about half, then keep it safely in a cool dry place with the temperature range as below; -20 °C to +45 °C (-4 °F to +113 °F) (within a month) -20 °C to +35 °C (-4 °F to +95 °F) (within three months) -20 °C to +25 °C (-4 °F to +77 °F) (within a year)

◇ Charging caution

- ⚠ **DANGER!** NEVER charge the battery pack in areas with extremely high temperatures, such as near fires or stoves, inside a sun heated car, or in direct sunlight. In such environments, the safety/protection circuit in the battery will activate, causing the battery to stop charging.

- **WARNING! NEVER** charge or leave the battery in the battery charger beyond the specified time for charging. If the battery is not completely charged by the specified time, stop charging and remove the battery from the battery charger. Continuing to charge the battery beyond the specified time limit may cause a fire, overheating, or the battery may rupture.
- **WARNING! NEVER** insert the transceiver (battery attached to the transceiver) into the charger if it is wet or soiled. This could corrode the battery charger terminals or damage the chargers. The chargers are not waterproof.
- **CAUTION! NEVER** charge the battery outside of the specified temperature range: 0 °C to +40 °C (+32 °F to +104 °F). Icom recommends charging the battery at +20 °C (+68 °F). The battery may heat up or rupture if charged out of the specified temperature range. Additionally, battery performance or battery life may be reduced.

■ Optional battery chargers

□ AD-110 installation

The AD-110 charger adapter must be installed into the BC-119N or BC-121N before battery charging.

- Connect the AD-110 charger adapter and the BC-119N/BC-121N as below, then install the AD-110 into the holder space of the BC-119N or BC-121N with the supplied screws.

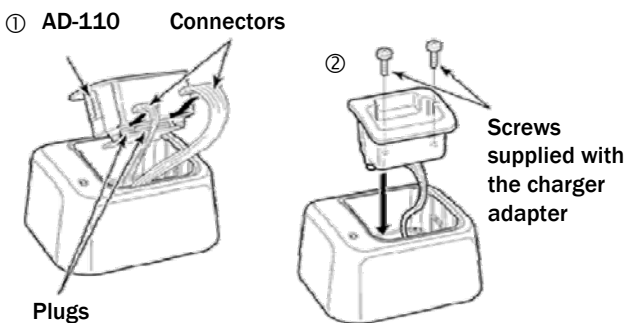

This illustration shows the BC-119N.

□ Rapid charging with the BC-119N+AD-110

The optional BC-119N provides rapid charging of the Li-Ion battery pack. Charging period: Approx. 4 hours (with BP-254)

The following items are additionally required.

- AD-110 charger adapter (purchase separately)
- An AC adapter (may be supplied with BC-119N depending on version) or the DC power cable (OPC-515L/CP-17L).

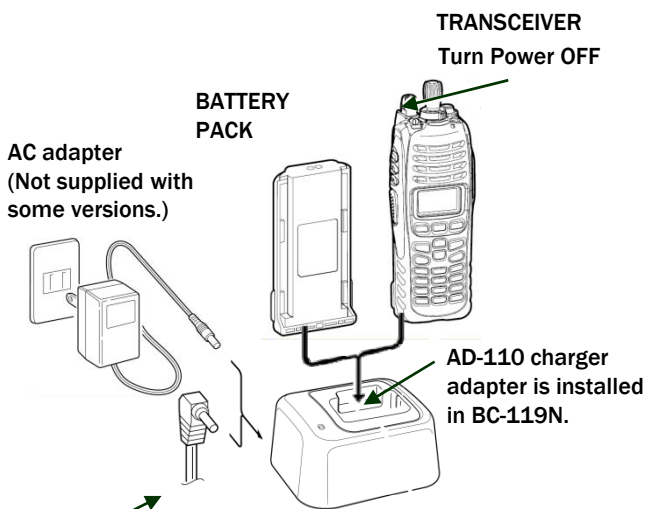

Optional OPC-515L (for 13.8 V power source) or CP-17L (for 12 V cigarette lighter socket) can be used instead of the AC adapter.

NOTE: Factory installed version available at Icom America with product code BC119N 61

□ Rapid charging with the BC-121N+AD-110

The optional BC-121N allows up to 6 battery packs to be charged simultaneously. Charging period: Approx. 4 hours (with BP-254)

The following items are additionally required.

- Six AD-110 charger adapters (purchase separately)
- An AC adapter (BC-157) or the DC power cable (OPC-656)

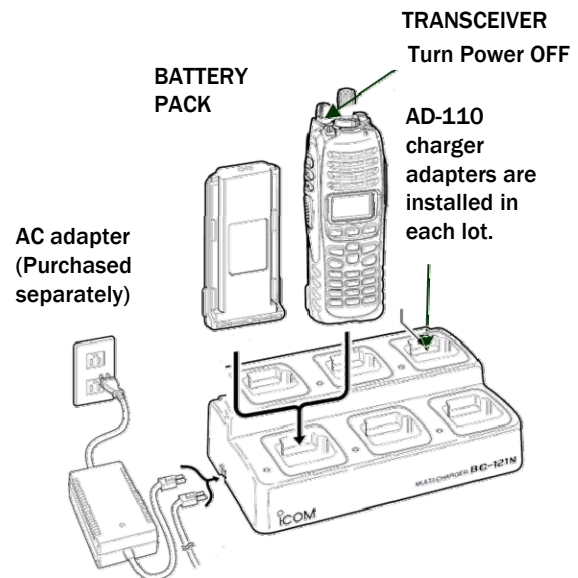

DC power cable (OPC-656)
(Connect with the DC power supply; 13.8 V/at least 7 A)

IMPORTANT: Battery charging caution

Ensure the guide tabs on the battery pack are correctly aligned with the guide rails inside the charger adapter.

(This illustration is described with the BC-119N).

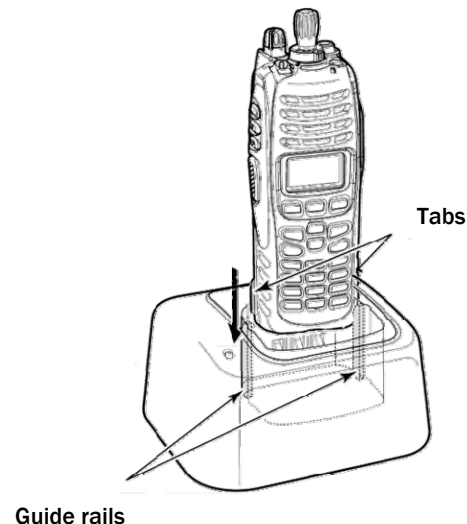

■ Supplied battery pack (BP-254)

This is one of the supplied accessories. Attach it to the radio according to the instructions in 3-1 Supplied Accessories Attachments.

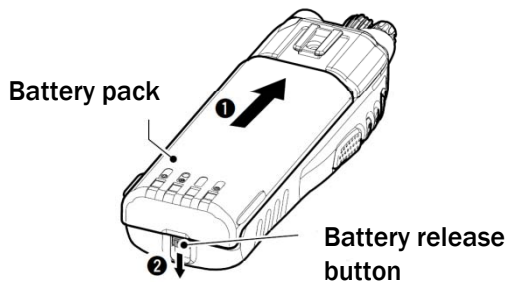

■ Optional battery case (BP-237)

The optional battery case uses 6 × AA (LR6) size alkaline batteries. Using alkaline batteries results in lower output power.

- ① Hook your finger under the latch, and open the cover in the direction of the arrow (1). (Fig.1)
- ② Then, install 6 × AA (LR6) size alkaline batteries. (Fig.2)
 - Install the alkaline batteries only.
 - Be sure to observe the correct polarity.
 - The ribbon should be accessible with the batteries installed.
- ③ Close the cover in the direction of the arrow (2) first, then check that the latch is in place (3). (Fig.1)
 - Be sure the gasket is aligned correctly, and does not protrude from the battery case. (Fig.3)

CAUTION:

- When installing batteries, make sure they are all the same brand, model and capacity. Also, do not use new and old batteries together.
- Keep battery contacts clean. It's a good idea to clean battery terminals once a week.
- Never incinerate used battery cells since internal battery gas may cause them to rupture.
- Never expose a detached battery case to water. If the battery case gets wet, be sure to wipe it dry before using it.

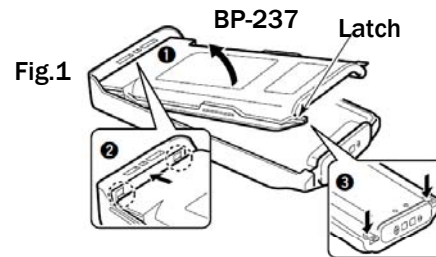

Fig.2

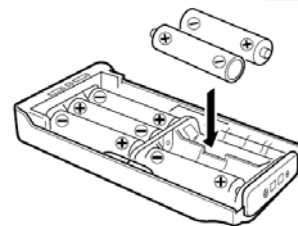
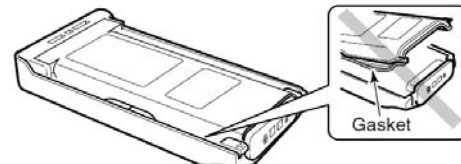

Fig.3



Battery pack	Voltage	Capacity	Battery life*3
BP-254 *1	7.4V	2900 mAh(min.) 3040 mAh(typ.)	9.5 hrs.
BP-237 *2	Battery case for A6 x AA (LR6) alkaline		— *4

1 The BP-254 meets IPX7 requirements for waterproof protection. When it is connected, the transceiver complies with IPX7.

2 The BP-237 meets IPX4 requirements for splash resistance. When it is connected, the transceiver complies with IPX4.

*3 When the power save function is turned ON, and the operating periods are calculated under the following conditions; TX : RX : standby = 5 : 5 : 90

*4 Operating period depends on the alkaline cells used.

NOTE:

* Once these items have been dropped, the IP rating cannot be guaranteed because of possible damage to these cases or the waterproof seal.

■ Optional Speaker Microphone (HM-184)

PTT SWITCH

Push and hold to Transmit;
Release to receive

Turn the transceiver power OFF before connecting the HM-184.

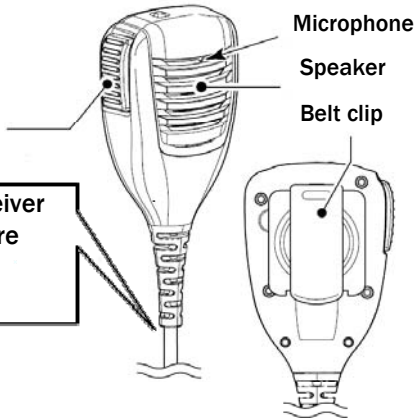

NEVER immerse the connector in water. If the connector becomes wet, be sure to dry it **BEFORE** attaching it to the transceiver.

NOTE: The microphone is located at the top of the speaker-microphone, as shown in the diagram above. To maximize the readability of your transmitted signal (voice), hold the microphone approx. 5 to 10 cm (2 to 4 inches) from your mouth, and speak in at normal voice level.

□ Attaching/Detaching belt clip

To detach the belt clip:

- ① Pinch the clip (①).
- ② Then slide the belt clip in the direction of the arrow (②).

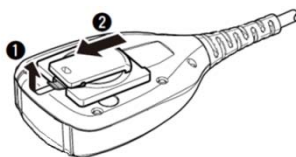

To attach the belt clip:

Slide the belt clip in the direction of the arrow (③) until the belt clip is locked and makes a 'click' sound.

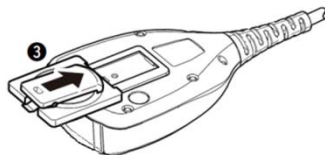

The clip rotates 360 degrees in 45-degree steps.



□ To attach

Attach the connector of the speaker-microphone into the multi-connector on the transceiver and tighten the screw.

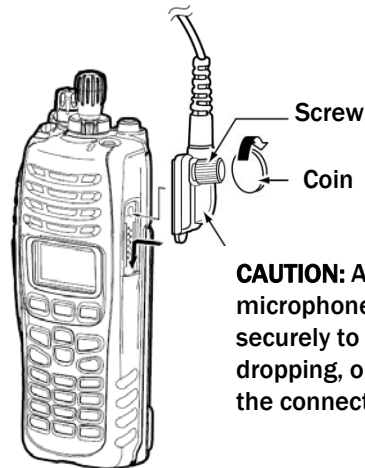

CAUTION: Attach the speaker-microphone's connector securely to prevent accidental dropping, or water intrusion in the connector.

IMPORTANT: **KEEP** the connector cover attached to the transceiver when the speaker-microphone is not in use.

Water will not get into the transceiver even if the cover is not attached, however, the terminals (pins) will become rusty, or the transceiver will function abnormally if the connector becomes wet.

The HM-184 meets IP57 requirements for waterproof protection. When it is connected, the transceiver complies with IP57. Once these items have been dropped, the IP rating cannot be guaranteed because of possible damage to these cases or the waterproof seal.

■ Optional VOX/PTT Unit (VS-1MC)

The VS-1MC is a VOX/PTT unit for Icom handheld transceivers, and allows you hands-free operation. An optional headset (HS-94, etc.) is required for operation.

- The VOX (Voice Operated Transmission) function starts transmission without pushing PTT switch when you speak into the microphone; then, automatically returns to receive when you stop speaking.

Features

- ➔ 14-pin spring-plug model head SP/MIC plug is equipped
- ➔ Water-resistant construction
- ➔ Durable construction
- ➔ Equipped with a PTT switch and revolving clip

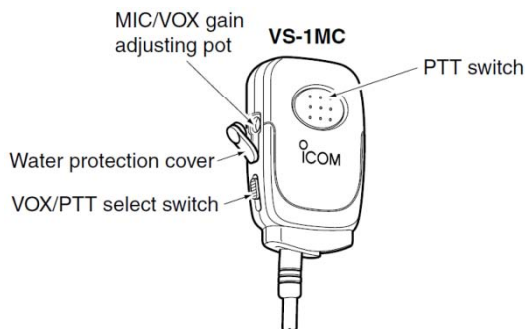

VOX gain and delay adjustment

- ① Attach the connector of the VS-1MC into the multi-connector on the transceiver and tighten the screw.
 - Toggle the VOX/PTT select switch to [VOX].
- ② Enter user set mode.
- ③ Push [◀] several times to select the “VOX Gain” or “VOX Delay” items. Then, push [▲] or [▼] to set the desired level/condition.
- ④ Push and hold [◀] again to exit the user set mode.
 - Until power is turned OFF, [◀], [▲] and [▼] do not activate their assigned key functions.

These adjustments are for Simple/10-key models only.

• VOX Gain

The VOX sensitivity level can be adjusted from OFF or 1 to 6 (more sensitive).

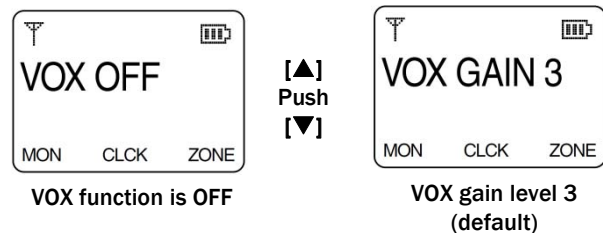

• VOX Delay

The VOX delay time can be set from 0.5 to 3.0 sec (0.5 sec step) for a convenient interval before returning to receive.

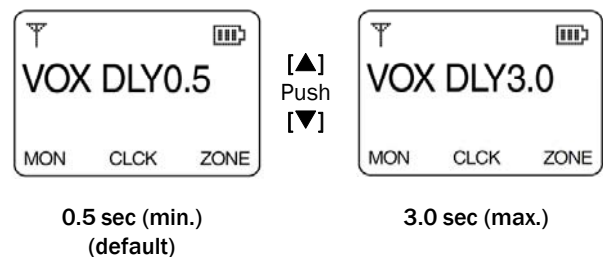

If your voice is detected, “TX” appears on the LCD as shown below during the VOX gain or VOX delay adjustment. (The transceiver does not transmit.)

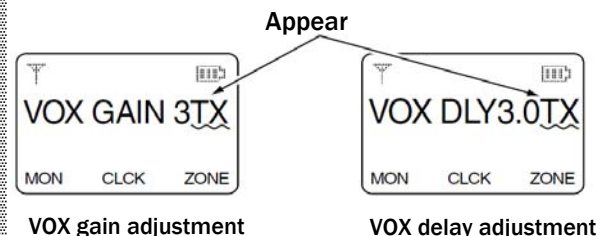

NOTE : MIC/VOX gain can be adjusted via the adjusting pot using a thin screwdriver.

The VS-1MC VOX/PTT CASE can be connected to the following Head Set.

- HS-94 : Ear-hook model
- HS-95 : Neck-arm model
- HS-97 : Throat microphone

VS-1MC : VOX/PTT switch box for hands-free operation, etc. has IPX4* waterproof protection. When in use, the transceiver’s waterproof rating meets IPX4 when it is connected.

Once these items have been dropped, the IP rating cannot be guaranteed because of possible damage to these cases or the waterproof seal.

3-3-6 Optional Internal Unit Installation

Unit Installation

The optional units add useful features to the IC-F9011 series. The optional units available with the IC-F9011 series are as follows. (See **3-2 Optional Accessories**.)

- UT-124R Man Down Unit
- UT-125 AES/DES Encryption Unit
- UT-128 DES Encryption Unit

CAUTION! Optional unit installation should be done at an authorized Icom service center only. The waterproof capability of the transceiver cannot be guaranteed if you install an unit yourself, or have it done at a non-authorized dealer/service center.

① Remove total of 2 knobs.

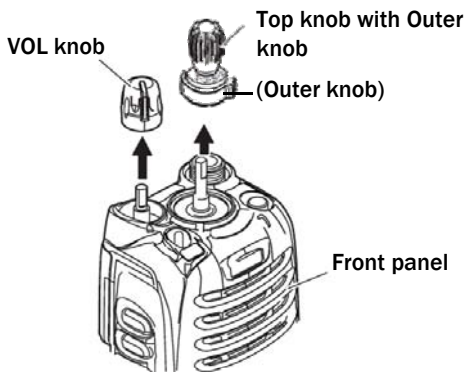

② Remove the antenna nut.

③ Unscrew 4 screws from the rear panel.

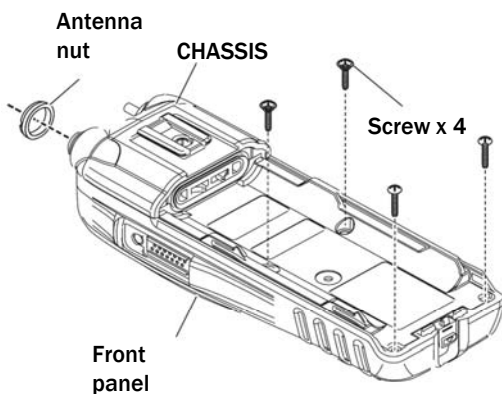

④ Turn the rear panel as below. No need to detach the flexible cables

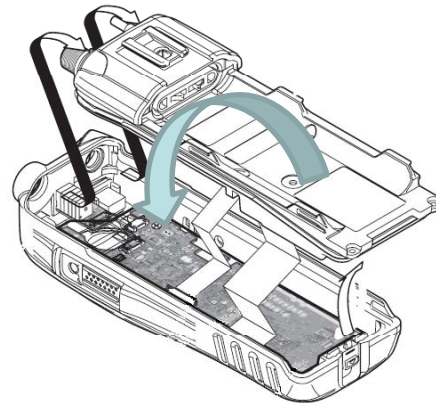

⑤ Attach the unit as below.

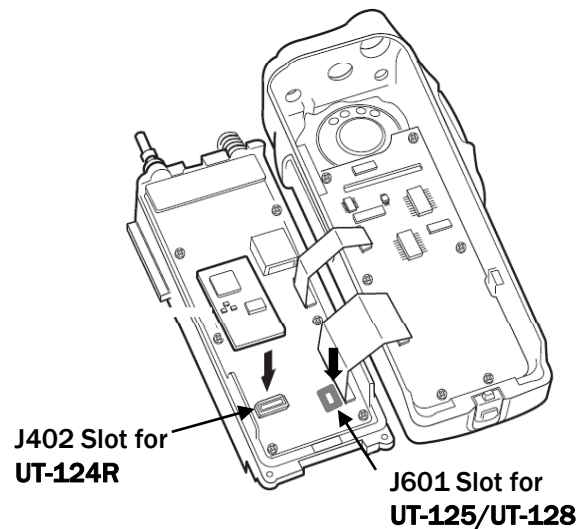

⑥ Recover the transceiver, and set or modify the setting using optional cloning software.

❑ Clock Back-up Battery Replacement

When the backup battery is discharged, the transceiver transmits and receives normally but cannot retain the current time.

- ① Separate the front panel from the CHASSIS.
(Refer to "DISASSEMBLY INSTRUCTION")
- ② Replace the clock backup battery, located on the FRONT UNIT as below. (Make sure the battery polarity is correct.)
- ③ Recover the transceiver, and re-set the date and time in set mode. (Refer to INSTRUCTION MANUAL)

CLOCK BACKUP BATTERY	
MAIN UNIT	: "BT1"
Part No.	: 3020000340
Part Name	: ML-614S/ZT

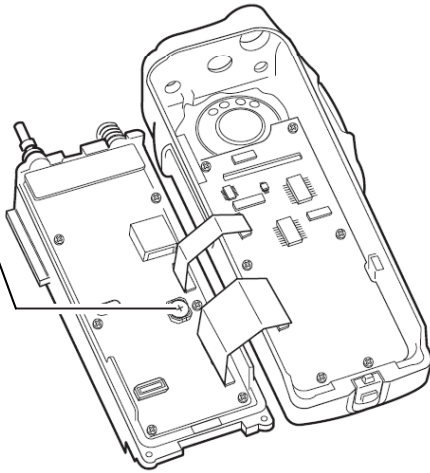

Battery removal

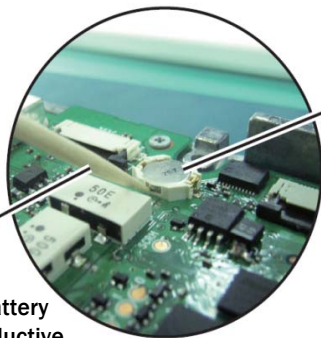

"+" side is UP

Remove old battery
using non-conductive
flat object

■ Front panel

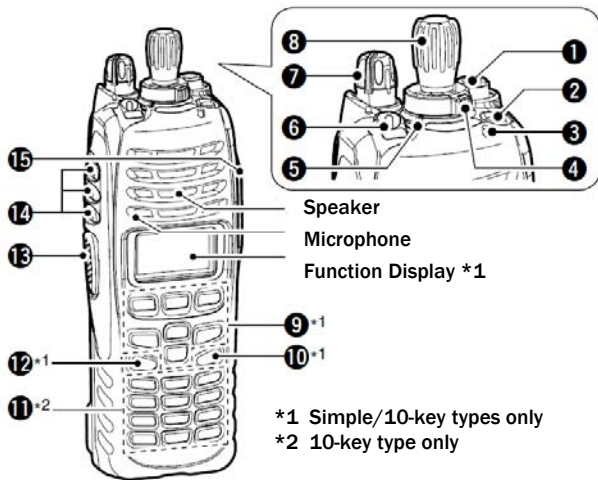

*1 Simple/10-key types only
*2 10-key type only

① ANTENNA CONNECTOR

Connects the supplied antenna.

② DEALER-PROGRAMMABLE KEY [EMR]

Desired function can be programmed by your dealer.

- [Emergency] is pre-programmed as default.

③ LED INDICATOR

- Lights green while receiving a signal, or when the squelch is open.
- Lights red while transmitting.
- The LED indicator indicates some information. (Non-display model only)

④ DEALER-PROGRAMMABLE ABC SWITCH

Desired functions can be programmed to each position (A, B or C) independently by your dealer. To activate the pre-programmed function, set the white line of the ABC switch to the position A, B or C.

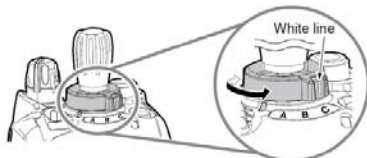

When the white line of the ABC switch is set to the position C, the pre-programmed function at position C will be activated.

⑤ CHANNEL INDICATOR

- Lights white according to the "Backlight" setting of the user set mode.
- When you rotate [Rotary selector] to select the channel or zone, align the desired channel/zone number with this point.

⑥ DEALER-PROGRAMMABLE TOGGLE SWITCH

Desired function can be programmed by your dealer. When the toggle switch is set to the left side (∅), the preprogrammed function will be activated.

⑦ VOLUME CONTROL [VOL]

Rotate to turn the power ON/OFF and adjusts the audio level.

⑧ ROTARY SELECTOR

- Rotate to select the pre-programmed memory channels or the operating zone. (Depending on the pre-set value)
- The channel/zone that is positioned to the channel indicator (⑤) is selected as the operating channel/zone.

⑨ DEALER-PROGRAMMABLE KEYS

[I]/[II]/[III]/[◀]/[▶]/[▲]/[▼] (Simple/10-key models only) Desired function can be programmed independently by your dealer.

⑩ APP KEY [APP] (Simple/10-key models only)

Desired function can be programmed by your dealer.

⑪ 10-KEYPAD (10-key model only)

The keypad allows you to enter digits to:

- Select memory channels, tone channels and DTMF codes (while in the DTMF code channel selection mode.)
- Start up with the password
- Input the Individual ID code for digital operation. (Depending on the pre-set value)

⑫ HOME KEY [HOME] (Simple/10-key models only)

Desired function can be programmed by your dealer. • [Home] is pre-programmed as default.

⑬ PTT SWITCH [PTT]

Push and hold to transmit; release to receive.

⑭ DEALER-PROGRAMMABLE KEYS

[Side1]/[Side2]/[Side3] Desired function can be programmed independently by your dealer.

⑮ MULTI-CONNECTOR

Connect optional equipment.

NOTE: Attach the connector cover when the optional speaker-microphone is not used.

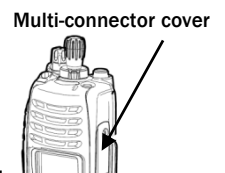

4-1-2 Function Display [Simple/Full Keypad Models Only]

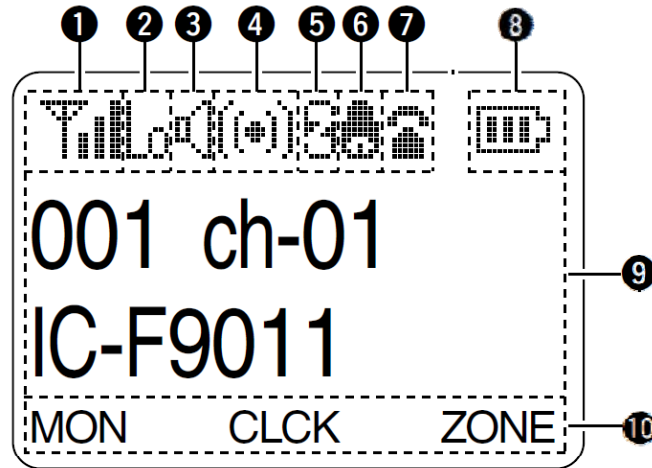

① SIGNAL STRENGTH INDICATOR

Indicates relative signal strength level.



② LOW POWER INDICATOR

Appears when low output power is selected.

- When high output power is selected, no indicator appears.

③ AUDIBLE INDICATOR

Appears when the channel is in the 'audible' (unmute) condition.

④ COMPANDER INDICATOR

Appears when the compander function* is activated.

- *Analog mode operation only.

⑤ SCRAMBLER INDICATOR

Appears when the voice scrambler function or encryption function is activated.

⑥ BELL INDICATOR

Appears/blinks when the specific page call* is received, according to the pre-programming.

- *P25 operation only.

⑦ TELEPHONE INDICATOR

Appears when a phone call* is received.

- *P25 operation only.

⑧ BATTERY INDICATOR

Appears or blinks when the battery power decreases to a specified level.

Indication				
Battery level	Full	Partly charged	Charging required	No battery

Blinks when the battery is exhausted.

⑨ ALPHANUMERIC DISPLAY

Displays an operating channel number, channel name, Set mode contents, DTMF code, etc.

⑩ KEY INDICATOR

Indicates the programmed function of the front panel keys ([I], [II], and [III]).

NOTES

See the operating guide for details of Analog and P25 Trunking/Conventional system operations. Consult your Icom dealer or system operator for details concerning your transceiver's programming.

Appearance of the icons on the LCD display depends on the function used and radio programming.

■ Programmable function keys

The following functions can be assigned to the following programmable function keys.

[EMERGENCY], [Side 1], [Side 2], [Side 3], [I]*, [II]*, [III]*, [◀]*, [▶]*, [▲]*, [▼]*, [APP]*, [HOME]*, ABC switch and Toggle switch.

*Simple/10-key models only

Consult your Icom dealer or system operator for details concerning your transceivers programming.

If the key indicator shows the programmed function key name, push the front panel key ([I],[II] or [III]) under the key indicator to activate the programmed function.

(The function key name in parentheses in the following explanation is displayed for that key indicator; e.g. "UF".

○ For Non-display model :

The programmable key functions are limited and some key functions operate differently on Simple/10-key models.

○ For ABC and Toggle switches:

The programmable key functions to ABC and Toggle switches are limited.

◇ For All models (Common operation)

PRIO A AND PRIO B KEYS "PRA" "PRB"

Push to select Priority A or Priority B channel.

MR-CH 1, MR-CH 2, MR-CH 3 AND MR-CH 4 KEYS "CH1" "CH2" "CH3" "CH4"

Push to select the memory channels 1,2,3 and 4 directly.

MONI KEY "MON"

- ➔ Push to mute and release the CTCSS (DTCS), NAC or Talkgroup ID squelch mute. Open any squelch/deactivate any mute while pushing and holding this key.
- ➔ Depending on the pre-set value, pushing and holding this key for 1 sec to cancel the scan. This function is valid on transceiver revision 1.3 or later.

LOCK KEY "LOCK"

Push and hold for 1 sec to electronically lock all programmable keys except the following: [PTT], [Moni], [Light], [Lock], [Emergency Single], [Emergency Repeat], [Surveillance] and [OPT 1/2/3].

Push and hold again for 1 sec, to turn the lock function OFF.

LIGHT KEY "LIGT"

Push to turn the transceiver's backlight ON for about 5 sec. When the backlight function is turned OFF in user set mode.

SURVEILLANCE KEY "SURV"

Push to turn the surveillance function ON and OFF. When this function is turned ON, the beep is not emitted and the LCD backlight does not light when a signal is received or a key is pushed, etc.

HOME KEY "HOME"

Push to return to the stand-by mode. After editing some information that needs to be memorized, push this key to save the edited contents in memory before returning to the stand-by mode.

OPT MOMENTARY KEYS "01M" "02M" "03M"

Push to control the output signal level from the optional unit connector.

◇ For All models

(Different operation with Non-display model)
When the following key functions are programmed in the Non-display model, the key functions may be limited and some key functions operate differently from Simple and 10-key models.

HIGH/LOW KEY "H/L"

- Push to select the transmit output power temporarily or permanently, depending on the pre-set value.
- Ask your dealer for the output power level for each selection.
 - Emits one beep when Low 1 is selected, two beeps when Low 2 is selected and three beeps when High is selected. (Non-display model only)

NOTE : Assigned functional key selection depends on programming software setup.

SCAN A KEY "SCNA"

○ For Simple/10-key models

- ➔ Push to start and cancel scanning operation. When Power ON Scan function is activated, push to pause the scanning operation. The paused scan resumes after the specified time period has passed.
- ➔ Push and hold this key for 1 sec to indicate the scan list, then push [CH Up] or [CH Down] to select the desired list. (Available depending on the pre-set value.)

○ For Non-display model

- Push to start and cancel scanning operation.
- When Power ON Scan function is activated, push to pause the scanning operation. And the paused scan resumes after the specified time period has passed.
 - LED indicator blinks green slowly while scanning.

SCAN B KEY "SCNB"

○ For Simple/10-key models

- ➔ Push to start and cancel scanning operation. The scan restarts after the specified time period has passed when the scan (started with this key) is cancelled by this key.
- ➔ Push and hold this key for 1 sec to display the scan list, push [CH Up] or [CH Down] to select the desired list.

○ For Non-display model

- Push to start and cancel scanning operation.
- The scan restarts after the specified time period has passed when the scan (started with this key) is cancelled by this key operation.
 - LED indicator blinks green slowly while scanning.

TALK AROUND KEY "TA"

(Conventional operation only)

The talk around function equalizes the transmit frequency to the receive frequency for transceiver-to-transceiver communication.

○ For Simple/10-key models

Push to turn the talk around function ON and OFF.

○ For Non-display model

- ➔ Push and hold for 1 sec to turn the talk around function ON.
- ➔ When the talk around function is ON, push to turn the function OFF.

PRIO A REWRITE AND PRIO B REWRITE KEYS

"PRAR" "PRBR"

○ For Simple/10-key models

- ➔ Push to select Priority A or Priority B channel.
- ➔ Push and hold [Prio A (Rewrite)] or [Prio B (Rewrite)] for 1 sec to rewrite the operating channel as the Priority A or Priority B channel.

OPT OUT KEYS "OP1" "OP2" "OP3"

For Simple/10-key models

Push to control the output signal level from the optional unit connector.

○ For Non-Display model

- ➔ Push and hold for 1 sec to control the output signal level from the optional unit connector.
- ➔ When this key function is activated, push to deactivate the function.

◇ For Simple/10-key models only

Following key functions cannot be programmed to Non-Display model.

CH UP AND DOWN KEYS "UP" "DOWN"

- ➔ Push to select an operating channel. When [Rotary selector] selection mode is "operating channel," this function is not available.
- ➔ Push to select a scan group after pushing and holding [Scan A Start/Stop]/[Scan B Start/Stop].

ZONE KEY "ZONE"

Push this key, then push [CH Up] or [CH Down] to select the desired zone.

When [Rotary selector] selects "operating zone", push this key to switch the range of selectable zones.

What is "zone" ? — Selected channels are assigned to a zone according to how they are to be used in a group. For example, 'Staff A' and 'Staff B' are assigned into a "Business" zone, and 'John' and 'Cindy' are assigned into a "Private" zone.

USER SET MODE KEY "SET"

- ➔ Push and hold for 1 sec to enter user set mode.
 - In the user set mode, push this key to select an item that is enabled by your dealer, and change the value or condition by pushing [CH Up] or [CH Down].
- ➔ Push and hold this key again for 1 sec to exit user set mode.

User set mode is also available via the 'Power ON function.'

CLOCK KEY "CLCK"

Push to display the current time on the LCD. While the current time is indicated, push and hold this key for 1 sec to enter the time data edit mode.

SCAN ADD/DEL (TAG) KEY "SCAD"

Push to add or delete the selected channel to/from the scan list.

1. Push to indicate the scan list, then push [CH Up] or [CH Down] to select the desired list.
2. Push to add or delete the channel to/from the selected scan list.
3. Push and hold for 1 sec to exit the scan list selection mode.

MENU < AND > MENU KEYS

([Menu <] and [Menu >] can only be assigned to [◀] and [▶], respectively.)

The menu mode is available when either [Menu <] or [Menu >] is assigned to [◀] or [▶]. During menu mode, the pre-programmed menu items (up to 15) are selected by the [I], [II] and [III] keys.

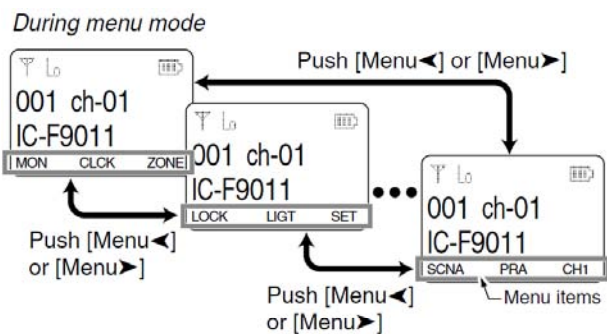

Push [Menu]/[Menu] to switch the previous/next 3 menu items, and push [I], [II] or [III] to activate the programmed function.

◇For ABC and Toggle switches only

ZONE SWITCH

Selects the pre-programmed zone directly.

PRIO A AND PRIO B SWITCHES

Selects Priority A or Priority B channel.

MR-CH 1, MR-CH 2, MR-CH 3 AND MR-CH 4 SWITCHES

Selects the memory channels 1,2,3 and 4, directly.

TALK-AROUND SWITCH (Conventional operation only)

Turn the talk-around function ON and OFF. The talk-around function sets the transmit frequency to be the same as the receive frequency for transceiver-to-transceiver communication.

LOCK SWITCH

Turns the lock function ON and OFF.

All programmable keys except the following are locked:

[PTT], [Moni], [Light], [Lock], [Emergency Single], [Emergency Repeat], [Surveillance] and [OPT 1/2/3].

HIGH/LOW SWITCH

Selects the transmit output power temporarily.

Ask your dealer for the output power level for each selection.

SURVEILLANCE SWITCH

Turns the surveillance function ON or OFF.

When this function is turned ON, the beep is not emitted and the LCD backlight does not light when a signal is received or a key is pushed, etc.

COMPANDER SWITCH

Turns the compander function ON and OFF.

The compander function reduces noise components from the transmitted audio to provide clear communication.

OPT MOMENTARY SWITCHES

Controls the output signal level from the optional unit connector.

■ Programmable key functions

The programmable key functions can be assigned to the following keys and switches;

[EMR], [Side1], [Side2], [Side3], [I]*1, [II]*1, [III]*1, [◀]*, [▶]*, [▲]*, [▼]*, [APP]*, [HOME]*1, ABC switch and Toggle switch.

*Available on Simple and 10-key models only

○ ABC and Toggle switches

The programmable key functions for the ABC and Toggle switches are limited.

○ Key indicator (Simple and 10-key models only)

If the key indicator shows the programmed function key name, push the front panel key ([I], [II] or [III]) under the key indicator to activate the programmed function. (In the explanations that follow, the function key name for that key indicator is displayed in double quotation marks; e.g. "EMR.")

○ Non-display model

The programmable key functions are limited, and some key functions operate differently between the Simple and 10-key models.

◇ Programmable key functions availability

The following chart shows the availability of the programmable key functions in Analog and APCO P25 modes of the IC-F9011 series.

NOTES for the following chart:

N/A: Not Applicable

*1 : Display and non-display units operate differently.

*2 : Not available on Non-display model.

Programmable key functions	Analog	APCO P25
CH Up/Down	✓	✓
Zone Up/Down	N/A	N/A
Zone	✓	✓
Scan A Start/Stop,	✓	✓
Scan B Start/Stop	✓	✓
Scan Add/Del(Tag)	✓	✓
PrioA, PrioB	✓	✓
PrioA(Rewrite), PrioB(Rewrite)	✓	✓
MR-CH 1, 2, 3, 4	✓	✓
Moni	✓	✓
Public Address	N/A	N/A
RX Speaker	N/A	N/A
Light	✓	✓
Lock	✓	✓
Talk Around	✓	✓
High/Low	✓	✓
Surveillance	✓	✓
Hook Scan	N/A	N/A
OPT1 Out, OPT2 Out, OPT3 Out	✓*1	✓*1
OPT1 Momentary, OPT2 Momentary, OPT3 Momentary	✓	✓
User Set Mode	✓*2	✓*2
Clock	✓	✓
Menu <, Menu >	✓	✓
Re-dial	✓	N/A
DTMF Autodial	✓*1	N/A
Scrambler	✓*1	N/A
Compander	✓*1	N/A
Lone Worker	✓	✓
Emergency	✓	✓
Ext.CH Sel Mode	N/A	N/A
Home	✓	✓
Scrambler/Encryption	✓*1	✓*1
Zeroize	N/A	✓
Site Lock	N/A	✓
Encryption	N/A	✓*1
Digital Button	N/A	✓*2
Digital Page	N/A	✓*2
Digital Status	N/A	✓*2
Digital Message	N/A	✓*2
Phone	N/A	✓*2
Individual	N/A	✓*2
Talkgroup	N/A	✓*2
Site Select	N/A	✓*2
Rekey	N/A	✓*2
Keyset	N/A	✓*2

◇ Analog mode operation

(Common operation)

RE-DIAL KEY "DTMR"

Push to transmit the last-transmitted DTMF code.
(Display and non-display units operate differently)

DTMF AUTODIAL KEY "DTMA"

○ For Simple and 10-key models

➔ Push to enter the DTMF channel selection mode.
Then select the desired channel using
[CH Up]/[CH Down] or [CH Up/Down].

➔ After selecting the channel, push this key to transmit the DTMF code.

○ For Non-display models

➔ Push to transmit the DTMF code.

SCRAMBLER KEY "SCR"

○ For Simple and 10-key models

Push to turn the Voice Scrambler function ON or OFF.

○ For Non-display models

➔ Push and hold for 1 sec to turn the Voice Scrambler function ON.

➔ If the function is ON, push the key to turn it OFF.

COMPANDER KEY "COMP"

○ For Simple and 10-key models

Push to turn the Compander function ON or OFF.
This function reduces noise components from the transmitted audio to provide clear communication.

○ For Non-display models

➔ Push and hold for 1 sec to turn the Compander function ON.

➔ If the function is ON, push the key to turn it OFF.

◇ Analog and APCO P25 modes operation (Common operation)

LONE WORKER KEY "LONE"

Push to turn the Lone Worker function ON or OFF.

- If the Lone Worker function is activated, the Emergency function is automatically turned ON after the specified time period* has passed with no operation performed.

* Depending on the pre-set value.

EMERGENCY KEY "EMR"

Push and hold for the specified time period*, to enter the emergency mode. After the specified time period* has passed, an Emergency call or alarm is transmitted once, or repeatedly.

- To exit the emergency mode, push and hold for the specified time period* again before transmitting.
- This function depends on the pre-set value.

Ext. CH Sel Mode KEY

(Available on only the mobile models)

Push to turn the Memory Channel Select from external input function ON or OFF.

When this function is turned ON, and a signal is input from an external unit connected to the D-sub 25-pin connector, the operating channel changes to the desired memory channel.

In this case, a memory channel selection with the key or dial operation, and the microphone hanger action functions, Move to Priority A Channel and On Hook Scan, are disabled. When this function is turned OFF, the memory channel selection from external input operation is disabled.

- This function is usable when an external unit is connected to the transceiver.
- Ask your dealer for details of the external input operation.

HOME KEY "HOME"

Push to return to the normal operating mode from each selected mode, such as Individual ID, Talkgroup ID, DTMF code channel, and so on.

(Display and non-display units operate differently)

When the Full Off Air Call SetUp (FOACSU) function is turned ON on the Trunking mode, push to ignore the receiving call.

SCRAMBLER/ENCRYPTION KEY "S/D"

(The optional UT-125 AES/DES encryption unit is required for encryption.)

○ For Simple and 10-key models

➔ While in the analog mode, push to turn the Voice Scrambler function ON or OFF.

➔ While in the APCO P25 mode, push to turn the Encryption function ON or OFF.

➔ While in the mixed (digital and analog) mode, push to turn the Voice Scrambler and Encryption functions ON or OFF, separately or simultaneously, as shown below.

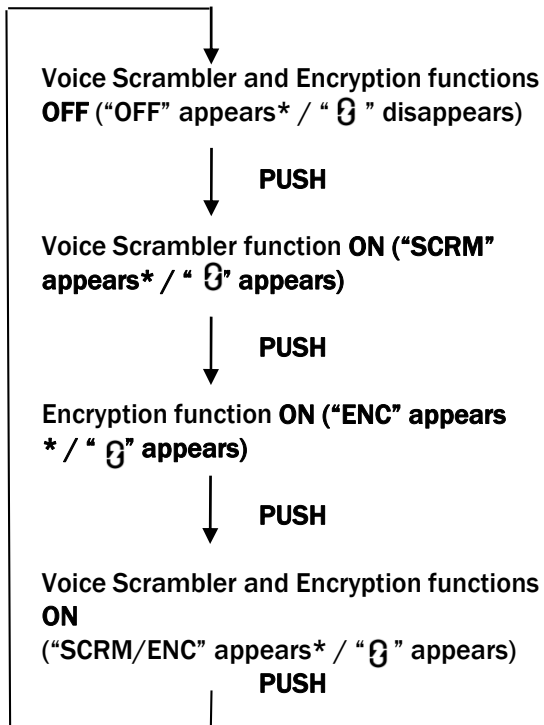

○ *For Non-display model*

- ➔ While in the analog mode, push and hold for 1 sec to turn the Voice Scrambler function ON. If the function is ON, push the key to turn it OFF.
- ➔ While in the APCO P25 mode, push and hold for 1 sec to turn the Encryption function ON. If the function is ON, push the key to turn it OFF.
- ➔ While in the mixed (digital and analog) mode, push and hold for 1 sec to turn both the Voice Scrambler and Encryption functions ON. If the functions are ON, push the key to turn them OFF.

◇ **For APCO P25 mode operation**

(Common operation)

ZEROIZE KEY "ZERO"

Push and hold this key for 1 sec to zeroize the encryption key data which is programmed by the key loader. After this operation is performed, the transceiver cannot decrypt the encrypted code.

SITE LOCK KEY "SLCK" (Trunking mode only)

Push to lock the transceiver in the current registered site. When the Site Lock function is activated, roaming and the background scan are inhibited. Push again to turn the Site Lock function OFF. (Display and non-display units operate differently)

ENCRYPTION KEY "DENC"

(The optional UT-125 AES/DES encryption unit is required.)

○ *For Simple and 10-key models*

Push to turn the Encryption function ON or OFF.

○ *For Non-display model*

➔ Push and hold for 1 sec to turn the Encryption function ON.

➔ If the function is ON, push the key to turn it OFF. (Not available for Non-display model)

DIGITAL BUTTON KEY "DSEL"

➔ Push to enter the digital call type selection mode. Then push [CH Up]/[CH Down] or rotate [CH Up/Down] to select the desired call type from "PAGE," "RDO INHIBIT," "RDO UINHIBIT," "RDO MONITOR," "RDO CHECK," "STATUS," "SHORT MSG," "STATUS QUERY," "PHONE" and "ANNOUNCEMENT." After making the digital call type selection, push this key again to enter the ID selection mode

- If "STATUS" or "SHORT MSG" is selected, the transceiver displays the Status Message or Short Message selection mode before entering the Individual ID selection mode.
- If "PHONE" is selected, the transceiver displays the phone number selection mode.
- If no operation is performed for about 30 sec, the transceiver returns to normal operation.

➔ Push and hold for 1 sec to cancel and return to normal operation.

DIGITAL PAGE KEY "PAGE"

➔ Push to enter the Individual ID selection mode for a Page call. Then push [CH Up]/[CH Down] or rotate [CH Up/Down] to select the desired Individual ID.

- Push [PTT] to transmit a Page call.
- If no operation is performed for about 30 sec, the transceiver returns to normal operation.

➔ Push and hold for 1 sec to cancel and return to normal operation.

DIGITAL STATUS KEY "STAT"

➔ Push to enter the Status Message selection mode. After selecting the desired Status Message, push again to enter the destination Individual ID selection mode to send a Status Message.

- If no operation is performed for about 30 sec, the transceiver returns to normal operation.
- While in the Trunking mode, the Individual ID selection mode does not appear.

➔ Push and hold for 1 sec to cancel and return to normal operation.

DIGITAL MESSAGE KEY "MSG"

- ➔ Push to enter the Short Message selection mode. After selecting the Short Message, push again to enter the destination Individual ID selection mode to send a Short Message.
 - If no operation is performed for about 30 sec, the transceiver returns to normal operation.
 - While in the Trunking mode, the Individual ID selection mode does not appear.
- ➔ Push and hold for 1 sec to cancel and return to normal operation.

PHONE KEY "PHON"

- ➔ Push to enter the phone number selection mode for a Phone call. Then push [CH Up]/[CH Down] or rotate [CH Up/Down] to select the desired phone number.
 - Push [PTT] to transmit the Phone call.
 - If no operation is performed for about 30 sec, the transceiver returns to normal operation.
- ➔ Push and hold for 1 sec to cancel and return to normal operation.

INDIVIDUAL KEY "INDV"

- Push to directly enter the Individual ID selection mode. Then select the desired Individual ID code using [CH Up]/[CH Down] or [CH Up/Down].
- The Individual ID can be edited with the 10-key pad*. (Depending on the pre-set value.)
*10-key model only.
 - While in the Individual ID selection mode, push to cancel and return to normal operation.

TALKGROUP KEY "TGID"

- Push to directly enter the Talkgroup ID selection mode. Then select the desired Talkgroup ID code using [CH Up]/[CH Down] or [CH Up/Down].
- During the Talkgroup ID selection, push to cancel and return to normal operation.

SITE SELECT KEY "SSEL" (Trunking mode only)

- Push to select "SITE 1," then push again to display the site information (RFSS ID and SITE ID), and you can edit the RFSS and SITE IDs. Push and hold [Site Select] for 1 sec to set and return to normal operation.

REKEY "REKY" (OTAR mode only)

- Push and hold for 1 sec to transmit a Key Management Message (KMM-Hello command) to a Key Management Facility (KMF) to request rekeying.

KEYSET "KSET" (OTAR mode only)

- ➔ Push to enter the keyset selection mode, then select the desired keyset using [CH Up]/[CH Down] or [CH Up/Down].
- ➔ During the keyset selection mode, push and hold this key for 1 sec to set the selected keyset, and push again to exit the keyset selection mode.

◇ For ABC and Toggle switches only

SCRAMBLER SWITCH (Analog mode only)

Turns the Voice Scrambler function ON or OFF.

COMPANDER SWITCH (Analog mode only)

Turns the Compander function ON or OFF. The Compander function reduces noise components from the transmitted audio to provide clear communication.

SCRAMBLER/ENCRYPTION SWITCH

(Analog and APCO P25 modes)

(The optional UT-125 AES/DES encryption unit is required for encryption.)

- ➔ While in the analog mode, turns the Voice Scrambler function ON or OFF.
- ➔ While in the P25 Conventional mode, turns the Encryption function ON or OFF.
- ➔ While in the mixed (digital and analog) mode, simultaneously turns the Voice Scrambler and Encryption functions ON or OFF.

ENCRYPTION SWITCH (APCO P25 mode only)

(The optional UT-125 AES/DES encryption unit is required.) Turns the Encryption function ON or OFF.

SITE LOCK SWITCH (APCO P25 Trunking mode only)





Locks the transceiver to the currently registered site. When the Site Lock function is activated, roaming and the background scan are inhibited.

■ Turning power ON

Prior to using the transceiver for the first time, the battery pack must be fully charged for optimum life and operation.

When you use the transceiver for the first time, or after the transceiver has sat unused for a long time, make sure to check the data and time indication after turning the power ON. If the time and date are not correct, reset them.

- ① Rotate [VOL] to turn the power ON.
- ② If the transceiver is programmed for a start-up password, input the digit codes as directed by your dealer.
 - 10-keypad can be used for password input depending on version.
 - The keys in the table below can be used for password input.
 - The transceiver detects numbers in the same block as identical. Therefore “01234” and “56789” are the same.

KEY					
NUMBER	0	1	2	3	4
	5	6	7	8	9

- ③ When the “PASSWORD” indication does not clear after entering 6 digits, the input code number may be incorrect. Turn the power off and start over in this case.

When you operate the Non-Display model, the password setting is not available.

■ Channel selection

Several types of channel selections are available. Methods may differ according to your system set up.

NOTE : When the Empty Channel Indication function is turned ON, “EMPTY” appears on the LCD when selecting an empty channel (no frequency is programmed), this function is valid on the transceiver’s revision 1.3 or later. (Simple/10-key models only)

NON-ZONE TYPE:

To select the desired zone:

- Push [CH Up] or [CH Down].
- Rotate [ROTARY SELECTOR]*
 - Up to pre-programmed 16 channels can be selected.
- Push one of [MR-CH 1] to [MR-CH 4].

ZONE TYPE:

To select the desired zone :

- Push [Zone], then push [CH Up] or [CH Down].
- Rotate [ROTARY SELECTOR] *.
 - Up to pre-programmed 16 zones can be selected.

AUTOMATIC SCAN TYPE :

Channel setting is not necessary for this type. When turning power ON, the transceiver automatically starts scanning. Scanning stops when receiving a call.

*Depending on the pre-set value.

When [Rotary selector] selects “Operating channel”, [CH Up]/[CH Down] are not available, and when [Rotary selector] selects “Operating zone”, [Zone]/[Zone Up]/[Zone Down] are not available.

■ Receiving and transmitting

NOTE: Transmitting without an antenna may damage the transceiver.

Receiving:

- ① Rotate [VOL] to turn the power ON.
- ② Push [CH Up] or [CH Down], or rotate [ROTARY SELECTOR]* to select a channel in sequence.
 - *Depending on the pre-set value.
- ③ When receiving a call, adjust the audio output level to a comfortable listening level.

Transmitting:

Wait for the channel to become clear to avoid interference.

- ① While pushing and holding [PTT], speak into the microphone at a normal voice level.
- ② Release [PTT] to return to receive.

IMPORTANT : To maximize the audio quality of your signal;

1. Pause briefly after pushing [PTT].
2. Hold the microphone 5 to 10 cm (2 to 4 in.) from your mouth, then speak into the microphone at a normal voice level.

◇Transmitting notes

• Transmit inhibit function

The transceiver has several inhibit functions which restrict transmission under the following conditions:

- The channel is in mute condition (‘Inaudible’ condition; ‘

33

- Un-matched (or matched) CTCSS is received. (Depending on the pre-set value.)
- Un-matched (or matched) NAC is received.* (Depending on the pre-set value.)
- The selected channel is a 'receive only' channel.

*Digital mode operation only.

• Time-out timer

After continuous transmission for the pre-programmed time period, the time-out timer is activated, causing the transceiver to stop transmitting.

• Penalty timer

Once the time-out timer is activated, transmission is further inhibited for a period determined by the penalty timer.

■ User set mode

User set mode is accessed at power ON and allows you to set seldom-changed settings. In this case you can “customize” the transceiver operation to suit your preferences and operating style.

When you operate the Non-display model, this function is not available.

Entering the user set mode:

- ① While pushing and holding [I] and [II], rotate [VOL] to turn the power ON.

- Turn power OFF in advance.
- SET MODE appears for 1 sec at power ON.

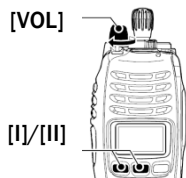

- ② Push and hold [◀] to enter user set mode.



- ③ Push [◀] several times to select the appropriate item. Then push [▲] or [▼] to set the desired level/condition.

- Available set mode functions are **Backlight, LCD contrast, Beep, Beep Level, Ringer Level, SQL Level, AF Min Level, Mic Gain, VOX Gain*1, VOX Delay*1, Horn Battery Voltage, Signal Moni, Lone Worker*2 and System info.**



*1 : Appears only when the external VOX unit is connected.

*2 : This function is valid on the transceiver's revision 1.3 or later.

- ④ Push and hold [◀] again to exit the user set mode.

- Until power is turned OFF, [◀], [▲] and [▼] is not activated as the assigned key function.

NOTE : While in the user set mode, [◀], [▲] and [▼] are activated as described above regardless of the assigned key function. User set mode is also available using a programmable key. See **4-1-3 Functions Programmable to Keys, User Set Mode Key.**

■ Clock function

The transceiver indicates the current time and date when [Clock] is pushed. And you can change the indication format and time/date settings.

This function is not available on a Non-display model.

When you use the transceiver for the first time, or after the transceiver has sat unused for a long time, make sure to check the date and time indication after turning the power ON. If the time and date are not correct, reset them.

◇ Time and date indication

- ① Push [Clock] to indicate the current time and date on the LCD.
 - When the indication format is set to 12-hour, “AM” or “PM” is indicated.
 - The LCD indication returns to the stand-by mode after 30 sec has passed with no operation.

The time indication format (12-hour/24-hour)

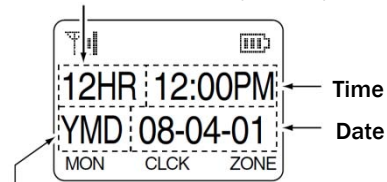

Date indication format (Y: Year, M: Month, D: Day)

- ② Push [Clock] again to return to the stand-by mode.

◇ Time and date settings

- ① Push [Clock] to indicate the current time and date on the LCD.



- ② Push and hold [Clock] for 1 sec to enter the time and date setting mode.

- The time indication format, “24HR” or “12HR” blinks.



- ③ Push and hold [Clock] for 1 sec to enter the time and date setting mode.

- The time indication format, “24HR” or “12HR” blinks.

- ④ Push [CH Up] or [CH Down] to set the selected item.

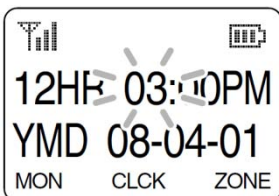

- ⑤ Push [Clock] to set. The next item blinks.

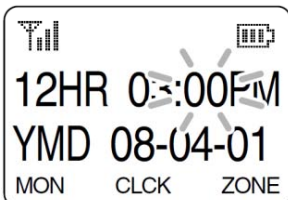

- ⑥ Repeat steps ③ to ⑤ to set items.
- ⑦ After setting, push and hold [Clock] for 1 sec to program.
- Return to the time and date setting mode.
- ⑧ Push [Clock] to return to the stand-by mode.

■ LED indicator (Non-display model only)

The LED indicator indicates some information as follows: (Ref.: R=Red, G=Green, O=Orange)

- TX: Lights red while transmitting a signal.



- TX low BATT1: TX is performed at Low BATT1.



- TX low BATT2: Low BATT2 was detected during TX mode.



- Fast/Slow scan: Blinks while Fast/Slow scan is activated.



- RX: Turns Green while receiving a signal.

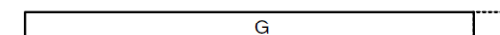

- Low BATT1: You should charge the battery. (blinks slowly)



- Low BATT2: You must charge the battery. (blinks fast)

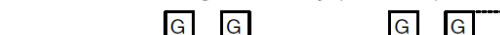

- CH err: Non-programmed channel is selected.



- The indicator lights (or blinks) orange when the optional battery case is attached.

- While hunting in trunking mode, the indicator blinks the same way as Fast/Slow Scan.

- Orange blinks when receiving the coded voice signal.



■ DTMF transmission

If the transceiver has **[DTMF Autodial]** assigned to it, the automatic DTMF Transmission function can be used. Up to 8 DTMF channels are selectable.

- ① Push **[DTMF Autodial]**— a DTMF channel appears.
- ② Push **[CH Up]** or **[CH Down]**, or rotate **[CH Up/Down]** to select the desired DTMF channel.
- ③ Push **[DTMF Autodial]** to transmit the DTMF code.

■ Scrambler function

The Voice Scrambler function provides private voice communication between users.

- ① Push **[Scrambler]** or **[Scrambler/Encryption]** to turn the Voice Scrambler function ON.
 - “” on handheld models appears. (Simple and 10-key models only)
- ② Push **[Scrambler]** or **[Scrambler/Encryption]** again to turn the function OFF.
 - “” on handheld models disappears. (Simple and 10-key models only)

■ Emergency transmission

When **[Emergency]** is pushed for the specified time period*, the DTMF emergency signal is transmitted once, or repeatedly, on the specified emergency channel. * Depending on the pre-set value.

A repeat emergency signal is automatically transmitted until the transceiver receives the acknowledgement signal or turning the transceiver power OFF.

When no emergency channel is specified, the signal is transmitted on the previously selected channel.

If you want to cancel the emergency call, push and hold **[Emergency]** again.

If your transceiver is programmed for Silent operation, you can transmit Emergency calls without the beep sounding or the LCD display lighting.

IMPORTANT: It is recommended to set an emergency channel individually to provide the dedicated emergency call operation.

NOTES

Depending on the pre-set value, the following functions are automatically activated.

• Auto TX function

The transceiver automatically transmits the microphone audio for the specified time period* after the emergency call transmission.

• Auto RX function

The transceiver stands by in the audible mode for the specified time period*, after the emergency call transmission.

* Depending on the pre-set value.

■ Man Down Emergency Call (Handheld models only)

This function requires the optional UT-124R Man Down Unit. When the transceiver has been left in a horizontal position for the specified time period*, the transceiver enters the emergency mode, and then the countdown starts. After the specified time period* has passed, an emergency call is automatically transmitted once, or repeatedly.

If the transceiver is placed in a vertical position before the first transmission, the transceiver exits the emergency mode and the emergency call is cancelled.

■ Lone Worker Emergency Call

When the Lone Worker function is activated, and the specified time period* has passed with no operation performed, the transceiver enters the emergency mode, and then the countdown starts.

After the specified time period* has passed, an emergency call is automatically transmitted once, or repeatedly. If someone operates the transceiver before transmission, the transceiver exits the emergency mode, and the emergency call is cancelled.

➡ Push **[Lone Worker]** to toggle the Lone Worker function ON or OFF.

* Depending on the pre-set values.

■ General

APCO Project-25 (P25) is designed for public safety digital radio, and allows you to make a call to a specific station (Individual call) or to a particular group (Talkgroup call or Announcement call*) in the Conventional and Trunking mode. Other P25 transceivers on the channel will not listen in on a call that does not match their Individual/Talkgroup/announcement group ID or NAC (Network Access Code).

Moreover, the following functions and calls are available:

- Pager function
- Radio Inhibit
- Uninhibit function
- Radio Monitor function
- Radio Check function
- Status Message,
- Short Message
- Status Query,
- Phone Call
- Emergency Call
- Encryption function.

NAC matching is not necessary for the above functions and calls.

Each transceiver has a unique ID, and it allows it to be substituted with an alphanumeric name, if programmed. You can use this ID (or name) to select a target station to call, and the ID (or name) of the target station is displayed after receiving a call.

*Trunking mode only

✓ **IMPORTANT for Trunking mode operation:**

- The public Trunking transceiver should be registered and group affiliated with the control channel in a current repeater system, to be operated in the Trunking mode. After the registration and group affiliation are successful, the Trunking operation can be performed.
- When the Full Off Air Call SetUp (FOACSU) function is turned ON, beeps sound after receiving an Individual call on the Trunking mode, which is a request for the user's permission to accept the call.

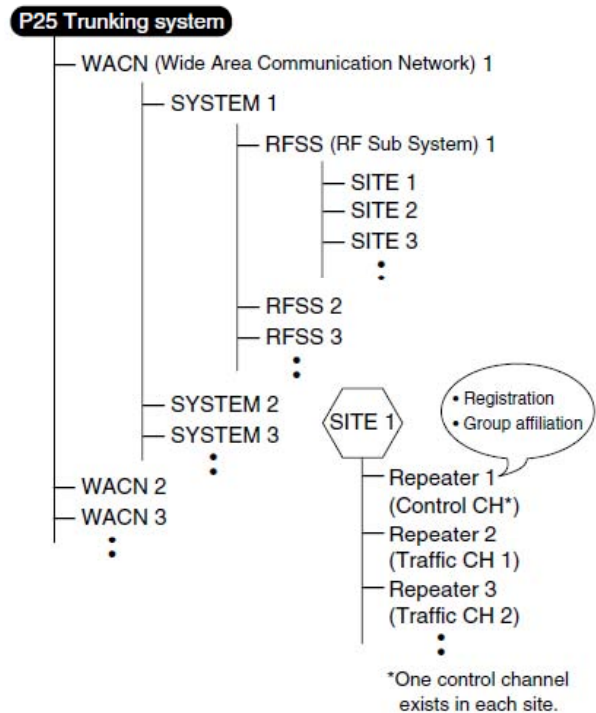

■ Control Channel Hunt function (P25 Trunking mode only)

The P25 Trunking mode allows the transceiver to automatically hunt for a control channel in a repeater system, according to the pre-programmed hunt list* when;

- Turning the power ON.
- The P25 Trunking mode is selected.
- The transceiver goes out of range and does not receive the downlink signal from the current registered control channel.

-“OUT OF RANGE” is displayed. (Simple and 10-key models only)

-S-meter icon is displayed according to the received signal strength level. (Simple and 10-key models only)

-“” is NOT indicated.

(Simple and 10-key models only)

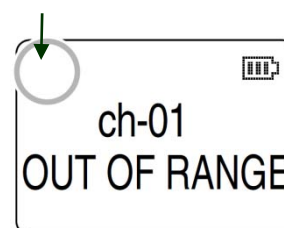

* The valid control channels (up to 64) are listed on the hunt list.

If the control channel is found, the transceiver attempts registration and group affiliation. Blinks when registration and group affiliation are performed. (Simple and 10-key models only)

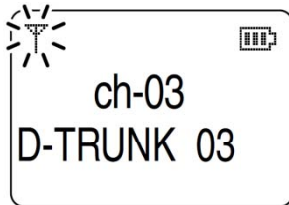

✓ **FAILED:**

The transceiver will continue to hunt for the next site.

✓ **SUCCEEDED:**

The transceiver can be operated in the P25 Trunking system.

Appears after registration and group affiliation are successful. (Simple and 10-key models only)

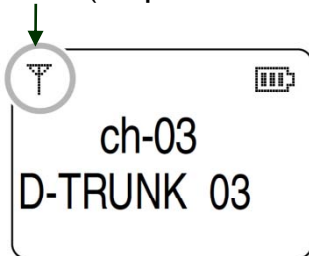

NOTE: "NO COMM" message is displayed, as illustrated below, when the group affiliation has failed (Simple and 10-key models only). In that case, change the operating channel or turn power OFF then ON again to retry hunting.

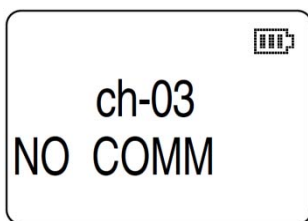

■ Roaming function (P25 Trunking mode only)

The P25 Trunking mode allows the transceiver to move to another system or WACN (Wide Area Communication Network), according to the pre-programmed roaming list*, in order to find a site that has a higher quality signal, or provides better services.

The Roaming function is automatically activated when the transceiver goes out of range and does not receive the downlink signal from the repeater in the current registered home system.

* The valid roaming areas (up to 10) are listed on the roaming list.

■ Site Lock function (P25 Trunking mode only)

The transceiver can be locked into the current site with [Site Lock].

When the Site Lock function is activated, roaming and the background scan are inhibited. This function is helpful when staying within one site and you don't want the transceiver to roam or scan other sites. However if the transceiver goes out of range and does not receive the downlink signal from the current site, the transceiver will automatically start hunting for a valid site, even if the Site Lock function is activated.

✓ **What is the Background Scan?**

When this function is ON, the transceiver always monitors a control channel of an adjacent site while operating in the registered site. (Default: OFF)

■ Site Select function (P25 Trunking mode only)

The RFSS and SITE IDs can be edited manually with [Site Select].

Not available on Non-display model.

To edit the RFSS and SITE IDs:

- ① Push [Site Select] to select "SITE 1."
- ② Push [Site Select] again to display the site information (RFSS ID and SITE ID).
- ③ Push [Site Select] to return to normal operation.
- ④ Push and hold [Site Select] for 1 sec to enter the RFSS ID edit mode.
- ⑤ Push [CH Up]/[CH Down] or rotate [CH Up/Down] to edit the ID. After editing, push [Site Select] to store the RFSS ID, and enter the SITE ID edit mode.
- ⑥ Repeat step ④ to edit.
- ⑦ Push and hold [Site Select] for 1 sec to return to "SITE 1" indication as in step ①.
- ⑧ Push and hold [Site Select] for 1 sec to store the SITE ID, and return to normal operation.

For P25 Trunking mode operation:

The transceiver should be registered and group affiliated with the control channel before the following operations can be performed.

■ Individual call

◇Transmitting

Individual call allows you to make a call to a specific station, and it provides private communication.

[Individual] key assignment is necessary to transmit the Individual call.

Not available on Non-display model.

① Push [Individual] to enter the Individual ID selection mode.

- "INDV" inverts to "INDV"
- A pre-programmed ID name is displayed.
- When the ID name is not programmed, the ID code is displayed.
- Push again to cancel and return to normal operation.

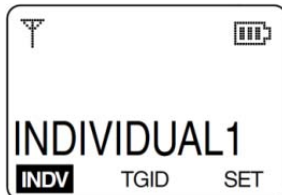

② Select the desired Individual ID (or name) using [CH Up]/[CH Down] or [CH Up/Down].

- The Individual ID can be edited with the 10-keypad*. (Depending on the pre-set value.)
- *10-key model only.

To edit the Individual ID using the 10-keypad:

Input the Individual ID directly with the 10-keypad.

- Push [*] to clear a code.

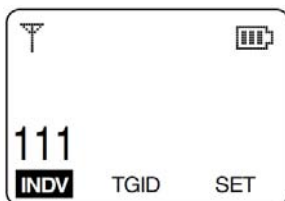

③ Push and hold [PTT] to transmit the Individual call to the target station, then speak into the microphone.

- The Busy/Transmit indicator lights red.
- Depending on the pre-set value, the target station does not open the squelch, and communication is not established, if the Individual ID or NAC (Network Access Code) is not matched.

④ Release [PTT] to receive.

◇Receiving

① When an Individual call is received;

- The Busy/Transmit indicator lights green.
- The ringer sounds. (Depending on the pre-setting.)
- The calling station ID (or name) is displayed for 2 sec. (Depending on the pre-set value.)
- Depending on the pre-set value, the transceiver does not open the squelch, and communication is not established, if the Individual ID or NAC (Network Access Code) is not matched. Ask your dealer for details.

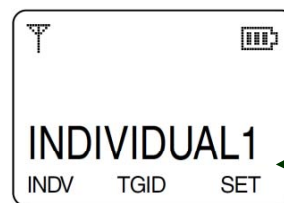

The calling station name (or ID)

② Push and hold [PTT] and speak into the microphone.

③ Release [PTT] to receive a response.

For P25 Trunking mode operation:

When the Full Off Air Call SetUp (FOACSU) function is turned ON, beeps sound after receiving a call. In that case, push [PTT] to accept the call. Then, operate as described in steps ② and ③ above. If you ignore the call by not pushing [PTT] for a specified time period*, communication is not established. Or, pushing [Home] after receiving the call will also ignore it. * Depending on the pre-set value.

■ Talkgroup call

◇Transmitting

A Talkgroup call allows you to make a call to a specific group only. [Talkgroup] key assignment is necessary to transmit the Talkgroup call.

✓ For Trunking mode operation:

The [Talkgroup] key is not usable while in the Trunking mode. To make a Talkgroup call, the group affiliation should be performed with the desired Talkgroup ID to call.

① Push [Talkgroup] to enter the Talkgroup ID (or name) selection mode.

- "TGID" inverts to "TGID"
- A pre-programmed ID name is displayed.
- When the ID name is not programmed, the ID code is displayed.
- Push again to cancel and return to normal operation.

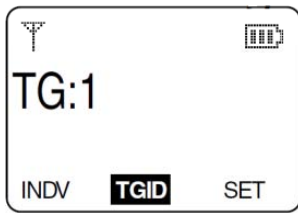

② Select the desired Talkgroup ID (or name) using [CH Up]/[CH Down], or [CH Up/Down].

NOTE: When '65535' is selected as the Talkgroup ID, All Call is an open call to everyone on your system.

③ Push and hold [PTT] to transmit the Talkgroup call to the specific group, then speak into the microphone.

- The Busy/Transmit indicator lights red.
- Depending on the pre-set value, the target station does not open the squelch, and communication is not established, if the Talkgroup ID or NAC (Network Access Code) is not matched. Ask your dealer for details.
- The Talkgroup ID (or name) is displayed for 2 sec when [PTT] is pushed. (Depending on the pre-set value.)

④ Release [PTT] to receive.

◇ Receiving

① When a Talkgroup call is received;

- The Busy/Transmit lights green.
- The ringer sounds. (Depending on the pre-setting.)
- The Talkgroup ID (or name) and calling station ID (or name) are displayed for 2 sec. (Depending on the pre-set value.)

"ALL CALL" is displayed instead of the Talkgroup ID (or name) when All Call is received.

- Depending on the pre-set value, the transceiver does not open the squelch, and communication is not established, if the Talkgroup ID or NAC (Network Access Code) is not matched.

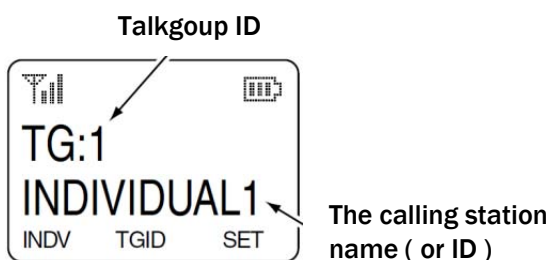

② Push and hold [PTT] and speak into the microphone.

NOTE: Only one station is permitted to speak at a time.

③ Release [PTT] to receive a response.

NOTE: When the Talkgroup ID is set to '65535,' any Talkgroup call can be received (if NAC is matched).

◇ Talkgroup display on mode change

The Talkgroup ID (or name) is displayed for 2 sec on the upper line of the LCD when the operating channel or zone is changed. This function can be turned OFF by your dealer.

◇ Talkgroup display on PTT

The Talkgroup ID (or name) is displayed for 2 sec on the upper line of the LCD when [PTT] is pushed. This function can be turned OFF by your dealer.

■ Pager function

◇ Transmitting

This function can be used as a "message pager" to confirm the target station of a caller's identification, even when the operator leaves the transceiver temporarily unattended. If the target station is active when receiving a signal, an acknowledgement is automatically transmitted. The caller station can verify whether a target station is active or not.

[Digital Button] or [Digital Page] key assignment is necessary to transmit the pager signal.

Not available on Non-display model.

① Push [Digital Button] to enter the digital call type selection mode.



✓ Quick access

Push [Digital Page] to directly enter the Individual ID selection mode. In this case, skip step ②.

② Push [**Digital Button**] again to enter the Individual ID selection mode.

- A pre-programmed ID name is displayed.
- When the ID name is not programmed, the ID code is displayed.

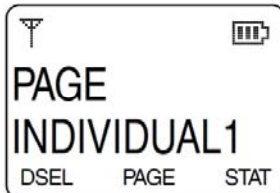

③ Push [**CH Up**] or [**CH Down**], or rotate [**CH Up/Down**] to select the desired ID (or name).

- Push and hold [**Digital Button**] or [**Digital Page**] for 1 sec to cancel and return to normal operation.
- The ID can be edited with the 10-keypad*.
- (Depending on the pre-set value.)
- * 10-key model only.

④ Push [**PTT**] to transmit the pager signal to the target station.

- The Busy/Transmit indicator lights red.
- "PLEASE WAIT" is displayed.

⑤ Release [**PTT**].

- "ACK RECEIVED" is displayed after receiving an acknowledgement from the target station, and then the transceiver returns to normal operation.
- "NO ACKNOWLEDG" is displayed when an acknowledgement is not received, and then transceiver returns to normal operation.

◇ Receiving

Not available on Non-display model.

① When a pager signal is received;

- The Busy/Transmit indicator lights green.
- The ringer sounds. (Depending on the pre-setting.)
- "📞" blinks. (Depending on the pre-set value.)
- "PAGE RECEIVED" and the calling station ID (or name) blink.

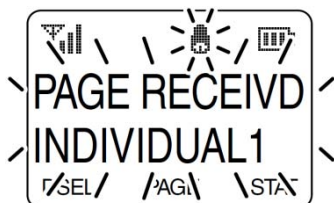

② An acknowledgement is automatically transmitted.

- The Busy/Transmit lights red.

③ Push any key (except for [0]) to stop the display from blinking and return to normal operation.

■ Radio Inhibit function

◇ Transmitting

A Radio Inhibit function allows you to send a signal that will inhibit (stun or kill, depending on the pre-set value) the target transceiver.

[**Digital Button**] key assignment is necessary to transmit the radio inhibit signal.

Not available on Non-display model in the Conventional P25.

✓ For Trunking mode operation:

This function is available only for a dispatcher in the Trunking mode.

① Push [**Digital Button**] to enter the digital call type selection mode.

② Push [**CH Up**] or [**CH Down**], or rotate [**CH Up/Down**] to select "RDO INHIBIT."



③ Push [**Digital Button**] again to enter the Individual ID selection mode.

- A pre-programmed ID name is displayed.
- When the ID name is not programmed, the ID code is displayed.

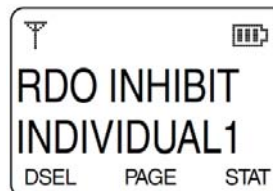

④ Push [**CH Up**] or [**CH Down**], or rotate [**CH Up/Down**] to select the desired ID (or name).

- Push and hold [**Digital Button**] for 1 sec to cancel and return to normal operation.
- The ID can be edited with the 10-keypad*.
- (Depending on the pre-set value.)

* 10-key model only.

⑤ Push **[PTT]** to transmit the radio inhibit signal to the target station.

- The Busy/Transmit indicator lights red.
- “PLEASE WAIT” is displayed.

⑥ Release **[PTT]**.

- “ACK RECEIVED” is displayed after receiving an acknowledgement from the target station, and then the transceiver returns to normal operation.
- “NO ACKNOWLEDG” is displayed when an acknowledgement is not received, and then transceiver returns to normal operation.

◇ Receiving

If a radio inhibit signal is received that matches your Individual ID, you cannot receive or transmit afterwards. (Depending on the pre-set value.)

① When a radio inhibit signal is received;

- The Busy/Transmit indicator lights green.
- The ringer sounds. (Depending on the pre-setting.)
- “SORRY” (default) appears. (Simple and 10-key models only)



② An acknowledgement is automatically transmitted.

- The Busy/Transmit indicator does not light because the radio inhibit is activated.

NOTE: The transceiver will not be revived until one of the following operations is performed. (Depending on the presetting.)

- Receiving a radio uninhibit signal.
- Entering the user passcode.

When the decode action is set to “Kill,” the cloning operation is necessary to revive.

■ Radio Uninhibit function

◇ Transmitting

A Radio Uninhibit function allows you to send a signal that will revive the inhibited transceiver. **[Digital Button]** key assignment is necessary to transmit the radio uninhibit signal.

Not available on Non-display model in the Conventional P25 mode.

✓ **For Trunking mode operation:**

This function is available only for a dispatcher in the Trunking mode.

① Push **[Digital Button]** to enter the digital call type selection mode.

② Push **[CH Up]** or **[CH Down]**, or rotate **[CH Up/Down]** to select “RDO UNINHIBIT.”



③ Push **[Digital Button]** again to enter the Individual ID selection mode.

- A pre-programmed ID name is displayed.
- When the ID name is not programmed, the ID code is displayed.

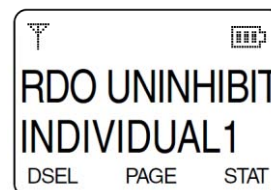

④ Push **[CH Up]** or **[CH Down]**, or rotate **[CH Up/Down]** to select the desired ID (or name).

- Push and hold **[Digital Button]** for 1 sec to cancel and return to normal operation.
 - The ID can be edited with the 10-keypad*.
- (Depending on the pre-set value.)
* 10-key model only

⑤ Push **[PTT]** to transmit the radio uninhibit signal to the target station.

- The Busy/Transmit indicator lights red.
- “PLEASE WAIT” is displayed.

⑥ Release **[PTT]**.

- “ACK RECEIVED” is displayed after receiving an acknowledgement from the target station, and then the transceiver returns to normal operation.
- “NO ACKNOWLEDG” is displayed when an acknowledgement is not received, and then transceiver returns to normal operation.

◇ Receiving (Reviving the transceiver)

A Radio uninhibit signal revives the inhibited transceiver.

- ① When an inhibited transceiver receives a radio uninhibit signal, the Busy/Transmit indicator does not light because the Radio Inhibit is still activated.
- ② An acknowledgement is automatically transmitted, and the transceiver is revived and returns to normal operation.
 - The Busy/Transmit indicator lights red.

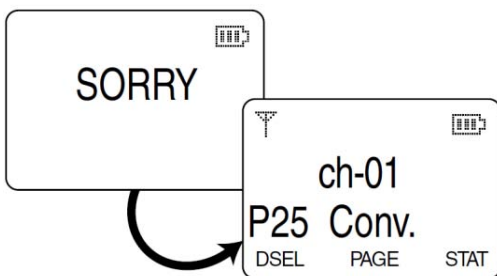

NOTE: If the transceiver is not revived even, after a radio uninhibit signal is received, cloning is required to revive it.

■ Remote Monitor function

◇ Transmitting

A Remote Monitor function allows you to send a signal that requires the target station to transmit audio from the microphone.

[Digital Button] key assignment is necessary to transmit the remote monitor signal.
(Not available on Non-display model)

- ① Push **[Digital Button]** to enter the digital call type selection mode.
- ② Push **[CH Up]** or **[CH Down]**, or rotate **[CH Up/Down]** to select “RDO MONITOR.”



- ③ Push **[Digital Button]** again to enter the Individual ID selection mode.

- A pre-programmed ID name is displayed.
- When the ID name is not programmed, the ID code is displayed.



- ④ Push **[CH Up]** or **[CH Down]**, or rotate **[CH Up/Down]** to select the desired ID (or name).
 - Push and hold **[Digital Button]** for 1 sec to cancel and return to normal operation.
 - The ID can be edited with the 10-keypad*.
(Depending on the pre-set value.)
*10-key model only.
- ⑤ Push **[PTT]** to transmit the remote monitor signal to the target station.
 - The Busy/Transmit indicator lights red.
 - “PLEASE WAIT” is displayed.
- ⑥ Release **[PTT]**.
 - “ACK RECEIVED” is displayed after receiving an acknowledgement from the target station, and then the transceiver returns to normal operation.
 - Busy indicator lights green.
 - “NO ACKNOWLEDG” is displayed when an acknowledgement is not received, and then the transceiver returns to normal operation.

◇ Receiving

- When a remote monitor signal is received, the transceiver automatically transmits an acknowledgement and audio*.
 - *The audio is transmitted for a pre-set time period.
 - The Busy/Transmit indicator lights green while receiving, and lights red while transmitting an acknowledgement or the audio.

✓ For Mobile transceivers operation:

When the optional SM-25 desktop microphone, HM-152T or HM-148T hand microphone is connected, the audio will not be transmitted.

■ Radio Check function

◇ Transmitting

A Radio Check function allows an operator to know if the target station is within communication range. The target station transceiver automatically responds after receiving a radio check signal. [Digital Button] key assignment is necessary to transmit the radio check signal.

Not available on Non-display model in the Conventional mode.

✓ For Trunking mode operation:

This function is available only for a dispatcher in the Trunking mode.

- ① Push [Digital Button] to enter the digital call type selection mode.
- ② Push [CH Up] or [CH Down], or rotate [CH Up/Down] to select "RDO CHECK."

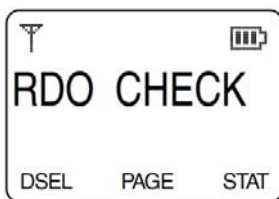

- ③ Push [Digital Button] again to enter the Individual ID selection mode.
 - A pre-programmed ID name is displayed.
 - When the ID name is not programmed, the ID code is displayed.

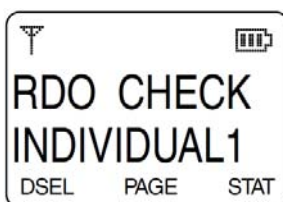

- ④ Push [CH Up] or [CH Down], or rotate [CH Up/Down] to select the desired ID (or name).
 - Push and hold [Digital Button] for 1 sec to cancel and return to normal operation.
 - The ID can be edited with the 10-keypad*. (Depending on the pre-set value.)
 - *10-key model only.
- ⑤ Push [PTT] to transmit the radio check signal to the target station.
 - The Busy/Transmit lights red.
 - "PLEASE WAIT" is displayed.

⑥ Release [PTT].

- "ACK RECEIVED" is displayed after receiving an acknowledgement from the target station, and then the transceiver returns to normal operation.
- Busy indicator lights green.
- "NO ACKNOWLEDG" is displayed when an acknowledgement is not received, and then transceiver returns to normal operation.

◇ Receiving

Not available on Non-display model in the conventional mode.

- ➔ When a radio check signal is received, the transceiver automatically transmits an acknowledgement.
 - The Busy/Transmit indicator lights green while receiving, and lights red while transmitting an acknowledgement.
 - The function display does not change while transmitting.

■ Status Message

◇ Transmitting

The transceiver can send one of up to 100 different pre-programmed Status Messages.

[Digital Button] or [Digital Status] key assignment is necessary to transmit the Status Message.

Not available on Non-display model.

✓ For Trunking mode operation:

The Status Message can be sent only to a dispatcher in the Trunking mode.

- ① Push [Digital Button] to enter the digital call type selection mode.

✓ Quick access

Push [Digital Status] to directly enter the Status Message selection mode. In this case, skip steps

② and ③. Go to step ④.

- ② Push [CH Up] or [CH Down], or rotate [CH Up/Down] to select "STATUS."

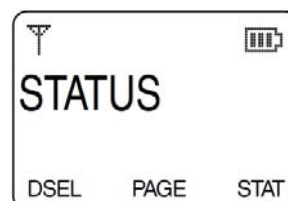

- ③ Push [**Digital Button**] again to enter the Status Message selection mode.
- A pre-programmed Status Message is displayed.

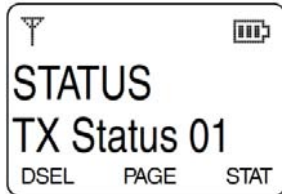

- ④ Push [**CH Up**] or [**CH Down**], or rotate [**CH Up/Down**] to select the desired Message.

While in the Trunking mode, the following steps ⑤ and ⑥ are not necessary. Go to step ⑦.

- ⑤ Push [**Digital Button**] (or [**Digital Status**]) again to enter the Individual ID selection mode.
- A pre-programmed ID name is displayed.
 - When the ID name is not programmed, the ID code is displayed.

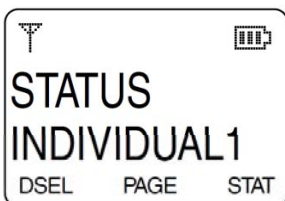

- ⑥ Push [**CH Up**] or [**CH Down**], or rotate [**CH Up/Down**] to select the desired ID (or name).
- Push and hold [**Digital Button**] (or [**Digital Status**]) for 1 sec to cancel and return to normal operation.
 - The ID can be edited with the 10-keypad*.
 - (Depending on the pre-set value.)
 - * 10-key model only.
- ⑦ Push [**PTT**] to transmit the Status Message to the target station.
- The Busy/Transmit indicator lights red.
 - “PLEASE WAIT” is displayed.
- ⑧ Release [**PTT**].
- “ACK RECEIVED” is displayed after receiving an acknowledgement from the target station, and then the transceiver returns to normal operation.
 - “NO ACKNOWLEDG” is displayed when an acknowledgement is not received, and then the transceiver returns to normal operation.

◇ Receiving

Not available on Non-display model.

- ① When a Status Message is received;
- The Busy/Transmit indicator lights green.
 - The ringer sounds.
 - (Depending on the pre-set value.)
 - The calling station ID name (or code) and the Status Message blinks.

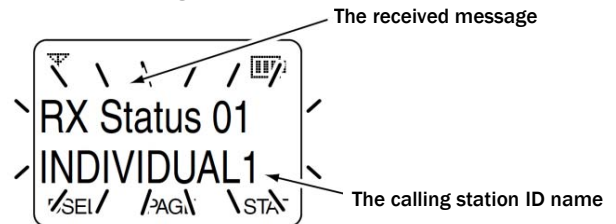

- ② An acknowledgement is automatically transmitted.
- The Busy/Transmit indicator lights red.
- ③ Push any key (except for [**Ⓚ**]) to stop the display from blinking and return to normal operation.

■ Short Message

◇ Transmitting

The transceiver can send one of up to 10 different pre-programmed Short Messages.

[**Digital Button**] or [**Digital Message**] key assignment is necessary to transmit the Short Message.

Not available on Non-display model.

✓ For Trunking mode operation:

The Short Message can be sent only to a dispatcher in the Trunking mode.

- ① Push [**Digital Button**] to enter the digital call type selection mode.

✓ Quick access

Push [**Digital Message**] to directly enter the Short Message selection mode. In this case, skip steps ② and ③. Go to step ④.

- ② Push [**CH Up**] or [**CH Down**], or rotate [**CH Up/Down**] to select “SHORT MSG.”



- ③ Push [**Digital Button**] again to enter the Short Message selection mode.
 *A pre-programmed Short Message is displayed.



- ④ Push [**CH Up**] or [**CH Down**], or rotate [**CH Up/Down**] to select the desired Short Message. While in the Trunking mode, the following steps ⑤ and ⑥ are not necessary. Go to step ⑦.

- ⑤ Push [**Digital Button**] (or [**Digital Message**]) again to enter the Individual ID selection mode.
 • A pre-programmed ID name is displayed.
 • When the ID name is not programmed, the ID code is displayed.

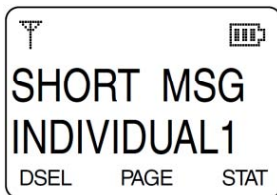

- ⑥ Push [**CH Up**] or [**CH Down**], or rotate [**CH Up/Down**] to select the desired ID (or name).
 • Push and hold [**Digital Button**] (or [**Digital Message**]) for 1 sec to cancel and return to normal operation.
 • The ID can be edited with the 10-keypad*. (Depending on the pre-set value.)
 * 10-key model only.

- ⑦ Push [**PTT**] to transmit the Short Message to the target station.
 • The Busy/Transmit lights red.
 • “PLEASE WAIT” is displayed.

- ⑧ Release [**PTT**].
 • “ACK RECEIVED” is displayed after receiving an acknowledgement from the target station, and then the transceiver returns to normal operation.
 • “NO ACKNOWLEDG” is displayed when an acknowledgement is not received, and then the transceiver returns to normal operation.

◇ Receiving

Not available on Non-display model.

- ① When a Short Message is received;
 • The Busy/Transmit lights green.
 • The ringer sounds. (Depending on the pre-set value.)
 • The calling station ID name (or code) and the Short Message blinks.

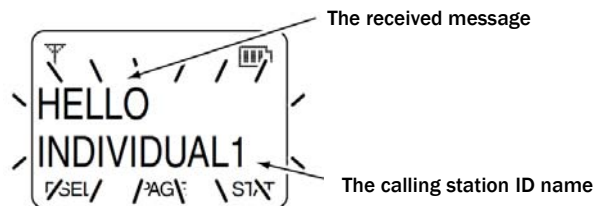

- ② An acknowledgement is automatically transmitted.
 • The Busy/Transmit lights red.
 ③ Push any key (except for ①) to stop the display from blinking and return to normal operation.

■ Status Query function

◇ Transmitting

A Status Query function allows you to send a signal that requests the last transmitted Status Message to the target station. The target station transceiver automatically responds after receiving a Status Query signal.

[**Digital Button**] key assignment is necessary to transmit the Status Query.

Not available on Non-display model.

- ① Push [**Digital Button**] to enter the digital call type selection mode.
 ② Push [**CH Up**] or [**CH Down**], or rotate [**CH Up/Down**] to select “STATUS QUERY.”



- ③ Push [**Digital Button**] again to enter the Individual ID selection mode.
 • A pre-programmed ID name is displayed.
 • When the ID name is not programmed, the ID code is displayed.



- ④ Push **[CH Up]** or **[CH Down]**, or rotate **[CH Up/Down]** to select the desired ID (or name.)
 - Push and hold **[Digital Button]** for 1 sec to cancel and return to normal operation.
 - The ID can be edited with the 10-keypad*. (Depending on the pre-set value.)
 - * 10-key model only.
- ⑤ Push **[PTT]** to transmit the status query signal to the target station.
 - The Busy/Transmit indicator lights red.
 - **"PLEASE WAIT"** is displayed.
- ⑥ Release **[PTT]**.
 - **"STATUS QUERY"** and the last transmitted Status Message by the target station blinks.
 - **"NO ACKNOWLEDG"** is displayed when an acknowledgement is not received, and then the transceiver returns to normal operation.

◇ Receiving

- Not available on Non-display model.
 - ➔ When a status transmitted Status Message is automatically transmitted.
 - The Busy/Transmit indicator lights green while receiving, and lights red while transmitting an acknowledgement or the Status Message.
 - The function display does not change while transmitting.

■ Phone call

◇ Transmitting

The transceiver can make a phone call that is similar to standard phone calls. A transceiver and a PSTN (Public Switched Telephone Network) can access each other.

If no phone number is pre-programmed, the Phone call function is not available.

[Digital Button] or **[Phone]** key assignment is necessary to transmit the Phone call.

Not available on Non-display model.

- ① Push **[Digital Button]** to enter the digital call type selection mode.
 - ✓ **Quick access**
 - Push **[Phone]** to enter the phone number selection mode directly. In this case, skip step ②.
 - Go to step ③.

- ② Push **[CH Up]** or **[CH Down]**, or rotate **[CH Up/Down]** to select "PHONE."

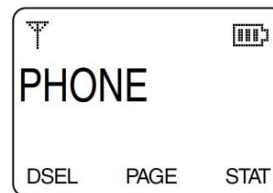

- ③ Push **[Digital Button]** again to enter the phone number selection mode.
 - A pre-programmed phone number and text are displayed.



- ④ Push **[CH Up]** or **[CH Down]**, or rotate **[CH Up/Down]** to select the desired phone number.
 - Push and hold **[Digital Button]** (or **[Phone]**) for 1 sec to cancel and return to normal operation.
 - The phone digits (0 to 9, M and #) can be edited with the 10-keypad*. (Depending on the pre-set value.)
 - *10-key model only.

To edit the Phone number with the 10-keypad:
Input the phone number directly with the 10-keypad.

- Push **[Digital Button]** (or **[Phone]**) to clear a code.



- ⑤ Push **[PTT]** to make a Phone call to the target telephone station.
 - The Busy/Transmit indicator lights red.
 - Beeps sound after the Phone call is connected to the target telephone station.
 - If your Phone call is not connected, push **[Digital Button]** (or **[Phone]**) to return to normal operation.
- ⑥ Push and hold **[PTT]** and speak into the microphone.
- ⑦ Release **[PTT]** to receive.
- ⑧ After the conversation is finished, push **[Digital Button]** (or **[Phone]**) to disconnect the Phone call and return to normal operation.

◇ Receiving

Not available on Non-display model.

- ① When a Phone call is received;
 - The Busy/Transmit indicator lights green.
 - The ringer sounds. (Depending on the pre-setting.)
 - **“PHONE CALL”** blinks.
 - The phone number of the calling telephone station is displayed. (Trunking mode only.)
 - **“☎”** blinks.



- ② Speak into the microphone while pushing and holding **[PTT]**.
 - The Busy/Transmit indicator lights red.
- ③ Release **[PTT]** to receive.
- ④ After the conversation is finished, push **[Digital Button]** (or **[Phone]**) to hang up and return to normal operation.

■ Announcement function

◇ Transmitting

The Announcement function allows you to send an announcement signal to only a specific group, and only in the Trunking mode. The members of the target group can only receive, and not transmit, announcements. **[Digital Button]** key assignment is necessary to use the Announcement function.

Not available on Non-display model.

- ① Push **[Digital Button]** to enter the digital call type selection mode.
- ② Push **[CH Up]** or **[CH Down]**, or rotate **[CH Up/Down]** to select **“ANNOUNCEMENT.”**



- ③ Push and hold **[PTT]** to transmit the announcement signal to the target group.
 - The Busy/Transmit indicator lights red.
- ④ Push and hold **[PTT]** and speak into the microphone.
- ⑤ Release **[PTT]** to stop transmitting.

◇ Receiving

Not available on Non-display model.

- ① When a matched announcement signal is received;
 - The Busy/Transmit indicator lights green.
 - The ringer sounds. (Depending on the pre-set value.)
 - **“ANNOUNCEMENT”** and calling station ID (or name) are displayed for 2 sec (Depending on the pre-set value.)



- ② You can listen to the announcement.

■ Emergency transmission

The P25 emergency mode can be accessed by pushing the **[Emergency]** key. An Emergency alarm is automatically transmitted once, or repeatedly*1, to the dispatcher (Trunking mode) or Talkgroup (Conventional P25 mode).

Moreover, while in the emergency mode, Emergency calls can be transmitted with **[PTT]** to a Talkgroup. If your transceiver is programmed for Silent operation, you can transmit Emergency alarms and Emergency calls without the beep sounding or the LCD display lighting.

[Emergency] key assignment is necessary to transmit the Emergency alarm.

NOTES:

When the Auto TX function is pre-set, the transceiver automatically transmits the microphone audio for the specified time period*2 after the emergency alarm transmission, even if the emergency repeat cycle is set to '1.' Ask your dealer for details.
 - An HM-148G or HM-152 hand microphone is required for the mobile transceivers.

When the Auto RX function is pre-set, the transceiver stands-by in the audible mode, for the specified time period*2, after the emergency alarm transmission.

*1 Depending on the emergency repeat cycle setting.
 *2 Depending on the pre-set value.

◇ **Transmitting an Emergency alarm**

- ① Push and hold [Emergency] for the specified time period*2 to enter the emergency mode.
 - The countdown starts immediately.
- ② After the specified time period*2 has passed, the transceiver automatically transmits an Emergency alarm once, or repeatedly, to inform the dispatcher that the transceiver is in the emergency condition.
 - To exit the emergency mode, push and hold [Emergency] before transmitting an Emergency alarm.
 - When the emergency repeat cycle is set to '1,' the transceiver transmits an Emergency alarm, exits the emergency mode and returns to normal operation.
 - After receiving an acknowledgement, "ACK RECEIVED" is displayed (Simple and 10-key models only), and depending on the pre-set value, the transceiver exits the emergency mode.
 - When an acknowledgement is not received, "NO ACKNOWLEDG" is displayed. (Simple and 10-key models only) And depending on the pre-set value, the transceiver automatically transmits the microphone audio (Auto TX).
- ③ To exit the emergency mode, turn the power OFF.

◇ **Transmitting an Emergency call along with an Emergency alarm**

- ① Push and hold [Emergency]*1 for the specified time period*2 to enter the emergency mode.
 - The countdown starts immediately.
- ② After the specified time period*2 has passed, the transceiver automatically, and repeatedly, transmits an Emergency alarm.
 - To exit the emergency mode, push and hold [Emergency] again before transmitting an Emergency alarm.
 - After receiving an acknowledgement, "ACK RECEIVED" is displayed (Simple and 10-key models only), and depending on the pre-set value, the transceiver exits the emergency mode.
 - When an acknowledgement is not received, "NO ACKNOWLEDG" is displayed. (Simple and 10-key models only) And depending on the pre-set value, the transceiver automatically transmits the microphone audio (Auto TX).
- ③ Push and hold [PTT] to transmit an Emergency call.
 - The Busy/Transmit indicator lights red.
- ④ To exit the emergency mode, turn the power OFF.

*1 : The emergency repeat cycle must be set to '2' or above.
 *2 : Depending on the pre-set value.

◇ **Receiving an Emergency alarm**

An Emergency alarm can be received only while in the Conventional mode. An emergency alarm decode action and automatic acknowledgement capability should be enabled by your dealer with the CS-F9010/F9510 cloning software.

- ① When an Emergency alarm is received;
 - The Busy/Transmit lights green.
 - The ringer sounds.
 - "EA RECEIVED" and the calling station ID (or name) blink. (Simple and 10-key models only)

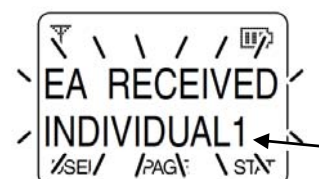

The calling station ID name

- ② An acknowledgement is automatically transmitted.
 - The Busy/Transmit lights red.
- ③ Push any key (except for [1]) to stop the display from blinking and return to normal operation.

◇ Receiving an Emergency Call

- ➔ When an Emergency call is received;
 - The Busy/Transmit indicator lights green.
 - The ringer sounds, depending on the pre-set value.
 - The pre-programmed emergency text (e.g. “EMERGENCY”) and the channel indication is displayed alternately. (Simple and 10-key models only)

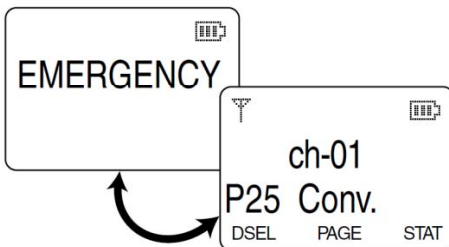

Depending on the pre-set values the calling station ID (or name) is displayed instead of the channel display.

■ Man Down Emergency Call (Handheld models only)

This function requires the optional UT-124R Man Down Unit. When the transceiver has been left in a horizontal position for the specified time period*, the transceiver enters the emergency mode, and then the countdown starts. After the specified time period* has passed, an emergency alarm is automatically transmitted once, or repeatedly.

If the transceiver is placed in a vertical position before the first transmission, the transceiver exits the emergency mode and the emergency alarm is cancelled. *Depending on the pre-set value.

■ Lone Worker Emergency Call

When the Lone Worker function is activated, and the specified time period* has passed with no operation is performed, the transceiver enters the emergency mode, and then the countdown starts. After the specified time period* has passed, an emergency alarm is automatically transmitted once, or repeatedly. If someone operates the transceiver before transmission, the transceiver exits the emergency mode, and the emergency alarm is cancelled. *Depending on the pre-set value.

- ➔ Push [Lone Worker] to toggle the Lone Worker function ON or OFF.

■ Encryption function

The Encryption function enables secure communication, which provides private digital voice communication between users.

- ① Push [Encryption] or [Scrambler/Encryption] to turn the Encryption function ON.
 - “E” appears. (Simple and 10-key models only)
- ② Push [Encryption] or [Scrambler/Encryption] again to turn the Encryption function OFF.
 - “E” disappears. (Simple and 10-key models only)

◇ Key Fail Indication

The transceiver indicates “Key Fail” for the specified time period* when the Common Key Reference (CKR) of the selected channel is not stored in the encryption unit. (Simple and 10-key models only)

◇ Decryption Multi Keys function

When this function is enabled, the transceiver releases the mute after receiving the audio signals for decryption, even if the CKR setting is not matched to the selected channel.

*Depending on the pre-set value.

■ OTAR function

P25 Over-The-Air-Rekeying (OTAR) function allows the Key Management Facility (KMF) to change the encryption keys in a transceiver remotely, (“over the air”) to protect the secure communications. Moreover, several OTAR commands are used to perform the following operations. See also 4-7 OTAR for this function.

From KMF to transceiver:

- Change Active Keyset
- Change Group RSI
- Radio Check
- The transceiver automatically responds to any command.

From transceiver to KMF:

- Registration to the OTAR system
- Deregistration from the OTAR system
- Rekeying

➤ When the channel in which the OTAR function is enabled is selected, the transceiver automatically attempts registration to the OTAR system by transmitting a Key Management Message (KMM) to KMF. Various other commands are exchanged between KMF and a transceiver, other than above.

ⓘ Not available on Non-display model.

◇ Registration to the OTAR system

➤ Push **[Zone]**, then push **[CH Up]** or **[CH Down]**, or rotate **[CH Up/Down]**, to select the channel in which the OTAR function is enabled. After selecting the channel, the transceiver automatically attempts registration to the OTAR system by transmitting a KMM 'Registration' command to KMF.

ⓘ **NOTE:** There are 2 types of KMM— Standard and Packet. If the pre-programmed KMM type is not matched to the system which the transceiver attempts to register with, the registration attempt may fail. In that case, the transceiver's KMM type should be changed to another type.

◇ Deregistration from the OTAR system

➤ Push **[CH Up]** or **[CH Down]**, or rotate **[CH Up/Down]**, to exit the channel in which the OTAR function is enabled. After exiting the channel, the transceiver automatically attempts deregistration from the OTAR system by transmitting a KMM 'Deregistration' command to KMF.

◇ Rekey request function

Normally, the encryption keys are managed and securely changed by KMF over the air without receiving a Rekey request. If needed, the transceiver can send a Rekey request to the KMF to perform the rekey operation.

- ① Push and hold **[Rekey]** for 1 sec to send a KMM 'Hello' command to KMF for a Rekey request.
 - "REQUEST REKE" appears.
- ② After receiving a Rekey request from the transceiver, KMF performs the rekey operation.
- ③ When the rekey operation is successful, "REQUEST REKE" disappears.
 - If the rekey operation fails, "FAILED" appears.

◇ Active Keypad selection

This function allows you to select the Active Keypad that is stored in the transceiver. The keypad structures a group of keys. By changing the keypad, the group of keys will be automatically switched to another group.

- ① Push **[Keypad]** to enter the keypad selection mode.
 - The selected keypad name ("KEYSET1" or "KEYSET2") appears.
- ② Push **[CH Up]** or **[CH Down]**, or rotate **[CH Up/Down]**, to select the desired keypad.
- ③ Push and hold **[Keypad]** for 1 sec to set the selected keypad.
- ④ Push **[Keypad]** to exit the keypad selection mode.

■ Tactical Group function

The Tactical Group function enables commonly used channels to be placed together in zone 128.

IMPORTANT!

The tactical group operation should be enabled by your dealer with the CS-F9010/F9510 cloning software. Ask your dealer for details.

Non-display model can be operated only as the sub transceiver.

◇ Creating the tactical group in zone 128

— Individual channel copy

- ① Push [CH Up] or [CH Down], or rotate [CH Up/Down] to select the channel which you wish to copy to zone 128, then turn power OFF.
- ② While pushing [I] and [III], rotate [VOL] to turn power ON.
 - “COPY ?” is displayed.
 - When all 512 channels are already used, the transceiver has no capacity. “NOT COPY” is displayed for 2 sec and error beeps sound.
 - Turn power OFF to cancel copy.
- ③ Push [◀] to copy the selected channel to zone 128.
 - “COPIED” is displayed.

◇ Creating the tactical group in zone 128

— Zone copy

- ① Push [CH Up] or [CH Down], or rotate [CH Up/Down] to select the channel belonging to the zone which you wish to copy to zone 128, then turn power OFF.
- ② While pushing [I] and [III], rotate [VOL] to turn power ON.
 - “COPY ?” is displayed.
 - When all 512 channels are already used, the transceiver has no remaining capacity. “NOT COPY” is displayed for 2 sec and error beeps are emitted.
 - Turn power OFF to cancel copy.
- ③ Push [CH Up] or [CH Down], or rotate [CH Up/Down] to select “ZONE COPY ?”.
- ④ Push [◀] to copy the selected zone data to zone 128.
 - “COPIED” is displayed.

NOTE:

When the transceiver does not have enough capacity to create the tactical group with zone copy, all channel data may not be copied completely.

◇ Clearing the tactical group in zone 128

— Individual channel clearing

- ① Push [CH Up] or [CH Down], or rotate [CH Up/Down] to select the channel which you wish to clear from zone 128, then turn power OFF.
- ② While pushing [I] and [III], rotate [VOL] to turn power ON.
 - “CLEAR ?” is displayed.
 - Turn power OFF to cancel clearing.
- ③ Push [◀] to clear the selected channel from zone 128.
 - “CLEARED” is displayed.

◇ Clearing the tactical group in zone 128

— Zone clearing

- ① Push [CH Up] or [CH Down], or rotate [CH Up/Down] to select a channel in zone 128, then turn power OFF.
- ② While pushing [I] and [III], rotate [VOL] to turn power ON.
 - “CLEAR ?” is displayed.
 - Turn power OFF to cancel clearing.
- ③ Push [CH Up] or [CH Down], or rotate [CH Up/Down] to select “ALL CLEAR ?”.
- ④ Push [◀] to clear the zone data from zone 128.
 - “ALL CLEARED” is displayed.

◇ Cloning the tactical group

<Master (Zone 128) → Sub (Zone 128)>

This operation enables the master transceiver to clone its own tactical group in zone 128 to zone 128 of the sub transceiver.

IMPORTANT!

To perform the tactical group cloning, “Set mode access” must be enabled, and the dealer pass code must be entered.

- ① Connect the two transceivers (master and sub) with the optional zone copy cable. The following zone copy cables are available;
 - **OPC-1870** : Used for the Handheld to Handheld connection.
 - **OPC-1871** : Used for the Handheld to Mobile connection.

☐ Handheld to Mobile connection

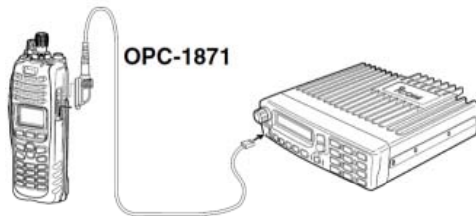

☐ Handheld to Handheld connection

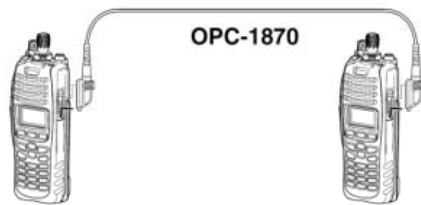

For actual appearance of the cables, please refer to **3-2 Optional Accessories**.

◇ Cloning the tactical group

<Master (Zone 128) → Sub (Zone 128)>
(Continued)

- ② Turn the sub transceiver power ON.
- ③ Set the master transceiver into the set mode as follows;

For Handheld models:

While pushing [◀] and [▶] on the master transceiver, rotate [VOL] to turn the power ON.

- “DEALER” is displayed.

- ④ Input the 6 digit dealer pass code, as specified by your dealer.
 - The 10-keypad* can be used for passcode input.
 - * 10-key model only
 - When using a Simple model transceiver, the keys in the table shown below can be used for pass code input.
 - The transceiver detects numbers in the same block as identical. Therefore 0 and 5, 1 and 6, etc. are the same.

KEY	[◀]	[I]	[II]	[III]	[▶]
NUMBER	0	1	2	3	4
	5	6	7	8	9

NOTE: When the “DEALER” indication does not clear after entering 6 digits, the input code number may be wrong. In that case, turn the power OFF, and start over.

NOTE: A default passcode is “159357”; Push [I], [◀], [▶], [III], [◀], [II] in sequence.
47 4 TACTICAL GROUP FUNCTION

- ⑤ If “SETMODE” is displayed after entering the dealer pass code, push [III] (for Handhelds)
 - “CLONE” is displayed.
- ⑥ Push [CH Up] or [CH Down], or rotate [CH Up/Down] to select “TACTICAL.”
- ⑦ Push [PTT] to copy zone 128 data of the master transceiver, to zone 128 of the sub transceiver.

NOTE: If [PTT] is pushed when “CLONE” is displayed, the regular cloning operation is performed (all data, including zone 128, of the master transceiver is written to the sub transceiver).

4-1-9 APCO P25 Trunking and Conventional Basic functions

This list shows each function that is supported by P25 trunking mode, by P25 conventional mode, or by both.

		Trunking System	Conventional System	Functions
1	Multiple Network Support	✓	✓	Enable the radio to operate on the multiple different networks by selecting new parameter in SU.
2	Internetwork Services	✓	/	Internet service. Check if the application is accessible to the internet or not.
3	Announcement Group Voice Call	✓	/	Similar to Broadcast Voice Call
4	Broadcast Voice Call	✓	✓	Voice group call with no indication of Source ID.
5	System Voice Call	✓	✓	All ID Call functions.
6	Unit to Unit Call	✓	✓	Individual call. Voice group call with no indication of Source ID.
7	Unit to/from PSTN	✓	/	Call from the radio terminal to the telephone network or vice versa.
8	Unit to PSTN Explicit Dialing Live Key Mode	✓	✓	Dialing function from the radio terminal to the telephone network, indicating adaptability to the dialing message of the trunking packet
9	Unit to PSTN Explicit Dialing Buffered Mode	✓	✓	Same as No.10
10	Unit to PSTN Explicit Dialing List Mode	✓	✓	Same as No.10
11	Emergency Call Request/Indication	✓	✓	Emergency call/Indication
12	Multiple Level Priority Call Request	✓	/	Call request with priority level. Priority level is set by control CH.
13	Rx P25 Squelch: monitor, normal,selective	✓	/	Rx squelch behavior
14	Tx P25 Squelch: None, Status Symbols,Carrier, Own Nacs, Other Nacs	✓	✓	Same as BUSY LOCK OUT before Tx
15	Channel Hunt	✓	/	Hunting control CH
16	Channel Hunt List	✓	/	List of Control CH to hunt
17	Channel Hunt Frequency Scan	✓	/	Fix the frequency of the control CH to search by conditions such as carrier sense.
18	Channel Scan		/	Scanning channels.
19	Priority Channel Scan		/	Scanning priority channels.
20	Background Scanning	✓	/	Same as the BBS in MPT-1324, looking for better channel than the one in current use.

		Trunking System	Conventional System	Functions
21	Priority Group Monitor	✓	/	Monitoring the arrival of groupcall signals with high priority level.
22	Emergency Alarm	✓	✓	Emergency alarm.
23	Call Alert	✓	✓	Call alert.
24	Short Message	✓	✓	Short message function
25	Status Update Request	✓	✓	Status message function
26	Status Query	✓	✓	Status message function
27	Status Query Response	✓	✓	Status message function
28	Radio Unit Monitor	✓	✓	External monitor function.
29	Radio Check	✓	✓	Checking radio validity
30	Receive Radio Inhibit & Uninhibit	✓	✓	Inhibit/un-inhibit the radio
31	Transmit Radio Inhibit & Uninhibit	/	✓	Inhibit/un-inhibit the radio
32	Radio Detach	✓	/	Cancel registration from repeater
33	Registration	✓	/	Registration to the radio from the repeater
34	Group Affiliation (CAI)	✓	/	Dynamic group function
35	Group Affiliation (Static)	✓	/	Dynamic group function
36	Roaming	✓	/	Roaming the trunking sites
37	Roaming Restriction	✓	/	Restrict roaming.
38	RFSS Site Lock	✓	/	Restrict movement of control CH.
39	Site Select	✓	/	Select control CH.
40	Type 3 Encryption	✓	✓	Indicate Type 3 encryption
41	Voice Encryption Support	✓	✓	Indicate voice encryption
42	Data Encryption Support	✓	✓	Indicate voice encryption
43	Over-the-air Rekeying (OTAR)	✓	✓	OTAR
44	Simple Static Key Security Parameter, Assignment	✓	✓	Functions using encryption key, group ID, CH selector etc.
45	TGID Security Parameter Assignment	✓	✓	Functions using encryption key for OTAR and group ID.
46	LLID Security Parameter Assignment	✓	✓	Functions using encryption key and logical ID.
47	Channel Selector Switch (CSS) Security, Parameter Assignment	✓	✓	Functions using encryption key and channel selector.
48	Packet Data	✓	✓	Packet Data communication ready

		Trunking System	Conventional System	Functions
49	Packet Data ARP	✓	/	Packet Data communication ready (APR)
50	UDP/IP (support for OS i/f or LwIP implementation)	✓	/	UDP/IP adaptable.
51	SLIP/PPP (support for OS i/f or LwIP implementation)	✓	/	SLIP/IP adaptable.
52	SNDP	✓	/	Subnetwork Dependent Convergence Protocol adaptable
53	Dual Mode Scanning	/	✓	Scanning in dual modes.
54	Dual Mode Monitoring	/	✓	Monitoring in dual mode.
55	Talkaround	/	✓	Talk around without repeaters
56	Talkback	✓	✓	Talk back function.

■ Getting started

- ◇ This cloning software is designed to perform data setting and cloning for the IC-F9011 series VHF P25 TRUNKING HANDHELD TRANSCEIVERS.
- ◇ **HELP WINDOW:** CS-F9010/F9510 has a help window to describe functions and operation.

■ System requirement

To use this program, the following hardware and software are required:

PC

- Microsoft® Windows® 2000/XP or Microsoft® Windows Vista ® is installed.
- USB port

Other item

Optional OPC-1862* CLONING CABLE (USB type)

NOTE:

To use the OPC-1862, USB type cloning cable, USB driver installation is necessary. The driver is supplied with the OPC-1862.

*The USB driver, supplied with the OPC-1862 is not supported for Microsoft® Windows Vista ®(64 bit).

■ Software installation

When installing the software, log in as the administrator.

- ① Quit all applications when Windows is running.
- ② Insert the CD into the appropriate CD drive.
- ③ Double-click the "Setup.exe" contained in the CD.
- ④ The "Welcome to the InstallShield Wizard for CS-F9010/ F9510" will appear as below. Click [Next>].

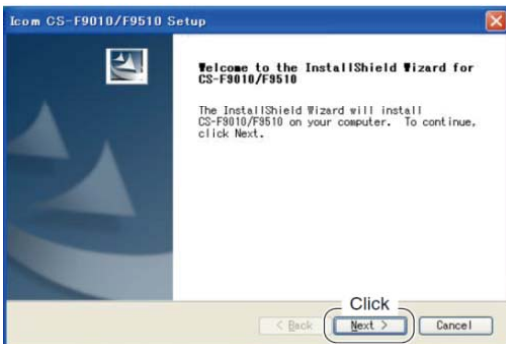

- ⑤ The "User Information" will appear as below, then type your name, your company name and the product ID number with the following manner. Then click [Next >].

- ID number: 305701-(6 digit serial number)
- Please check the serial number on the CD. If you have obtained the software by the download service, enter the ID which was provided from the distributor.

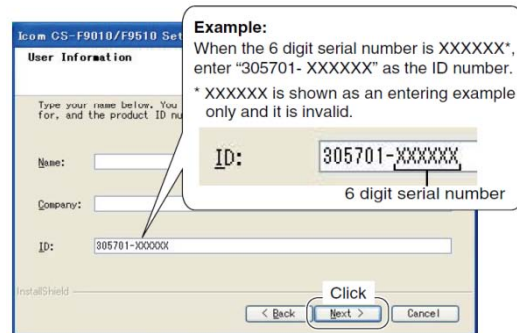

- ⑥ The "Choose Destination Location" will appear as below. Then click [Next>] to install the software to the destination folder. (e.g. C:\Program Files\Icom\CS-F9010_F9510)
 - Click [Browse...] to select another destination folder before clicking [Next >], if desired.
- ⑦ After the installation is completed, the "InstallShield Wizard Complete" will appear as below. Then click [Finish].
- ⑧ Eject the CD.

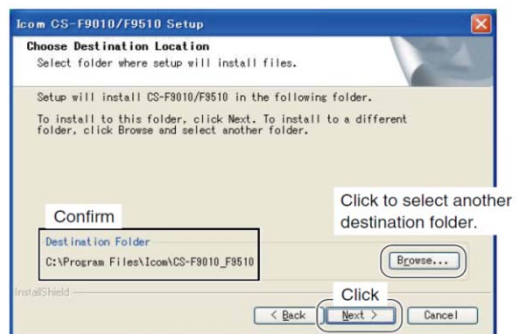

- ⑨ Program group 'CS-F9010_F9510' appears in the 'Programs' folder of the start menu, and 'CS-F9010_F9510' short cut icon appears on the desktop screen.
 - To uninstall the cloning software, select the "Control Panel" in the start menu, and click the "Add or Remove Programs." Then, select the program group 'Icom CS-F9010/9510' and click [Remove].

■ Connections

All cloning operations are performed from the computer's keyboard—the operation required on the transceiver side is;

- ① First, connect the cloning cable as illustrated below.
- ② Then, rotate [VOL] to turn power ON.

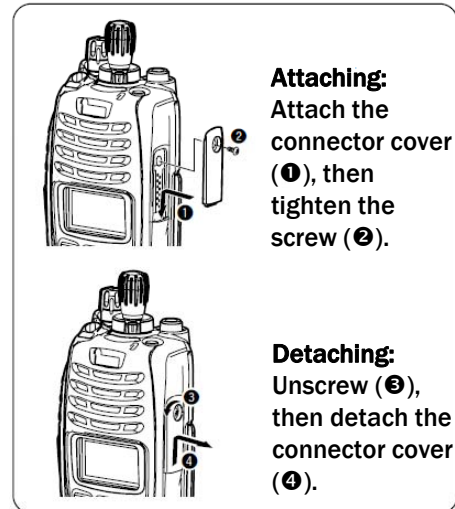
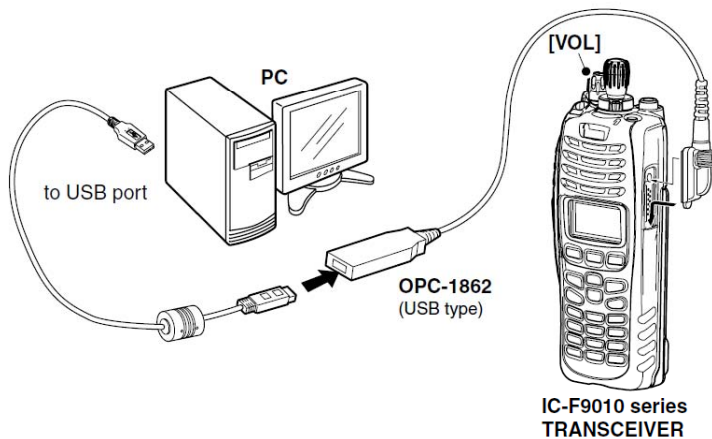

□ Screen description

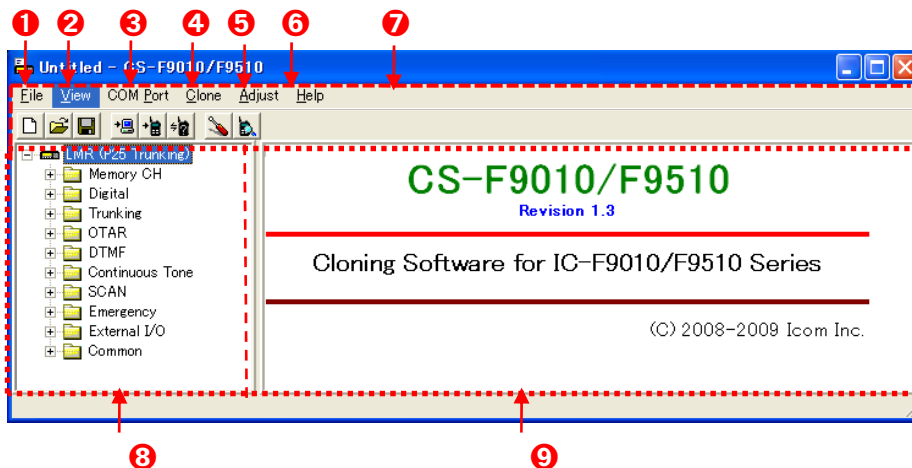

1. FILE MENU [File]

Used for saving memory channel contents, printing the pre-programmed information or exiting the program, etc.

2. VIEW MENU [View]

- Selects the displayed font size.
- Turn the tool bar indication ON or OFF.

3. COM PORT MENU [COM Port]

- Click to display the COM port (1 to 4 and More) setting dialog box.
- Set the transfer speed (Normal or High).

NOTE: 'Check the following' dialog box appears when the COM port is not set correctly.

4. CLONING MENU [Clone]

Click to display the cloning menu and cloning information dialog box.

5. Adjust

Program the adjustment frequencies in the zone screen.

6. HELP MENU [Help]

Click to display the help contents and cloning software revision information.

7. TOOL BAR

Shortcut buttons appear on the tool bar when the tool bar indication is turned ON in the [View] menu.

8. TREE VIEW SCREEN

Click the folder icon which you want to edit.

9. CONTENTS LIST SCREEN

Display the contents list (Memory CH information, Common settings, etc.).

■ Programming information

We recommend that you review all of the transceiver's data before entering/editing parameters even when the transceiver is factory fresh.

- Double-click the desired cell in the contents list screen directory, or right-click the cell to display the edit menu. Then click **[Edit... Enter]** to select and change the setting depending on the item.
- Click **[Help]** to display the help screen for the item.

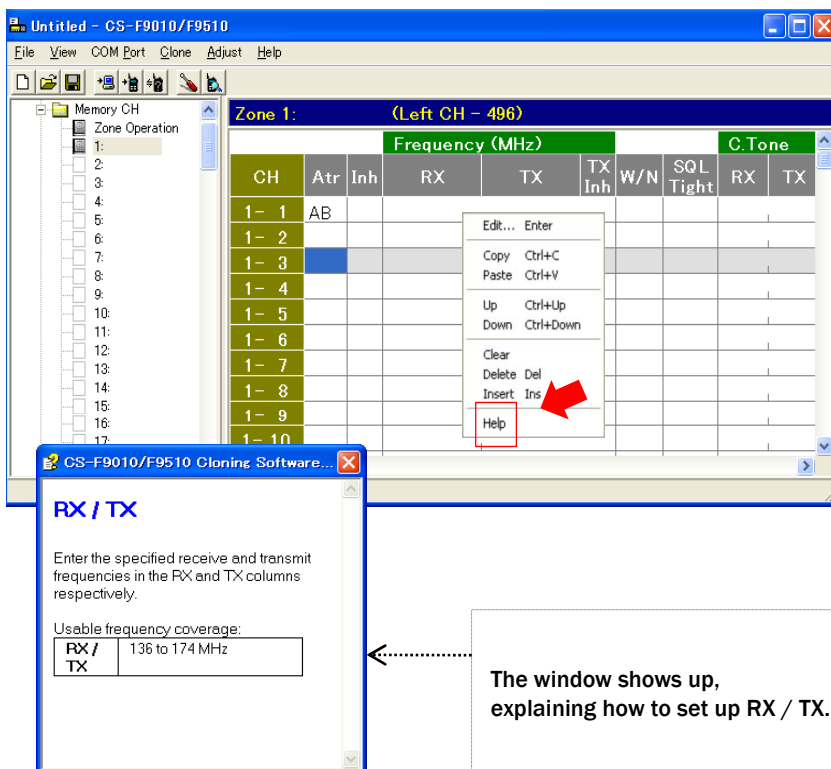

NOTE: The above instructions are for reference only. Please refer to the HELP file of the cloning software when you don't understand the function or setting meaning.

IC-F9011 series

Connect the cloning cable, OPC-1862 to the multi-connector first and then rotate [VOL] clockwise to turn power ON.

Click or select <Read <- TR> in the [Clone] menu to read out all radio's programmed cloning data into PC before editing with this cloning software. Otherwise, the cloning data may not be cloned correctly to the radio. (e.g. Memory CH, DTMF, Common, etc.)

Introduction

CS-F9010/F9510 cloning software is designed to perform data setting and cloning for the IC-F9011 series VHF P25 TRUNKING HANDHELD TRANSCEIVERS, and the IC-F9510 series VHF P25 TRUNKING MOBILE TRANSCEIVER.

-Launching the CS-F9010/F9510 Cloning Software

1. Before launching the program, make sure the radio's power is turned ON.
2. Click the [Start] button and point to [Programs].
3. Point to the CS-F9010/F9510 folder.
4. Click the CS-F9010/F9510 program. (or simply double click desktop short cut "CS-F9010/F9510," which automatically created during software installation.)



NOTE:

- Please restart the software if you see an error dialog box even when the connected radio is powered on.
- If the problem persists, check the connection between the computer and radio, as well as the COM port.



RELATED ITEMS

Confirming the COM port
Changing the COM port

➤ Quitting the CS-F9010/F9510 program
Select [Exit (X)] in the [File (F)] menu or click the close button [X] on the title bar.

Opening Screen

The Opening Screen consists of Top menu, Tool Bar, Tree View and Contents list screen.

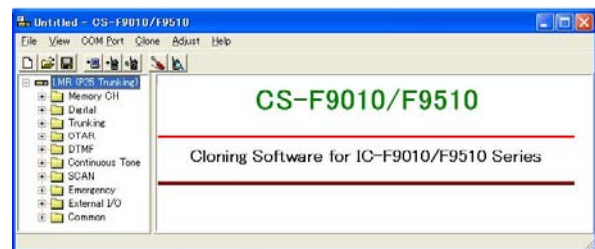

Memory CH

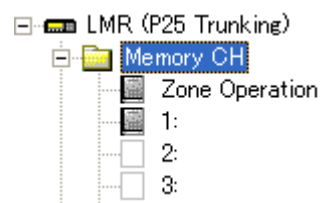

➤ Zone Operation

Set zone conditions, each zone name and capacity (number of channels). A total of 128 zone settings are available. Also, show the number of memory channels condition for reference.

➤ Zone

Set the operating frequency and details of the operating conditions for each memory channel that is assigned into a zone.

Digital

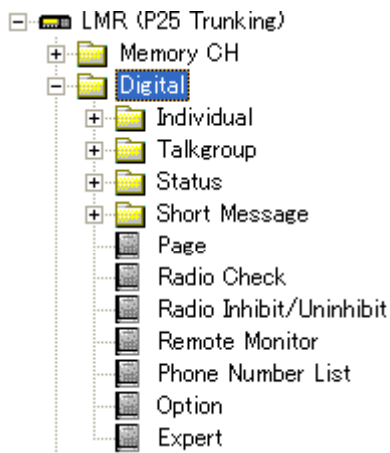

➤ Individual

Set the individual ID with hexadecimal or decimal format and enter the ID name.

➤ Talk-group

Set the talk-group ID with hexadecimal or decimal and enter the ID name.

➤ Status

Set the Rx and Tx status.

➤ Short message

Enter up to a 12-character message that will be displayed at transmission and reception of a short message. Ten messages are available.

➤ Page

Page call is designed to notify the targeted radio user who may be away from his/her radio or in noisy environment with alert and indication. Select 'enable' if required.

➤ Radio Check

Radio check call is designed to determine whether the targeted station is turned on, within the communication range and on channel without requiring any action to the targeted radio user. This call causes a targeted radio to send an acknowledgment automatically. Select 'enable' if required.

➤ Radio Inhibit/Un-inhibit

The radio inhibit (stun or kill) calls/or/un-inhibit (revive) cause the targeted radio to automatically send an acknowledgment and to be unusable/or/usable.

➤ Remote Monitor

Set the TX to make a call to listen to the targeted radio's audio frequency without requiring any action from the targeted radio user.

➤ Phone Number List

Make a list for easy recognition of the phone number.

➤ Option

Optional functions are selectable in Individual, Talkgroup, Config, Call option, and encryption.

➤ Expert

Set P25 Parameters, Lockout, and scan extension time.

Trunking

Trunking enables further effective channel management by sharing a minimum of channels with a large number of users. Set in System Registration, Hunt List, Roaming List, and CH ID List. Please see [4-2-3 APCO P25 Clone Soft Setting](#) for details.

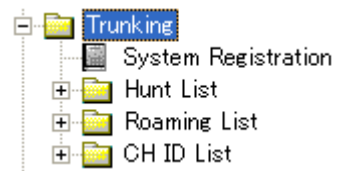

OTAR

OTAR (Over-The-Air-Rekeying) is the common name for the method of changing encryption keys in a two-way radio system over the radio channel ("over the air"). The keys can be changed over the IP network (SNDP setting is required).

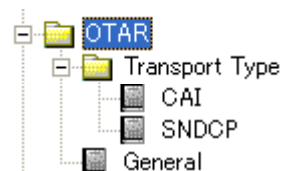

DTMF

➤ DTMF Autodial

Enter the DTMF Code and Text.



➤DTMF Settings

Set the time period/signal length for the DTMF Timer, First Timer, * # Timer.

Continuous Tone

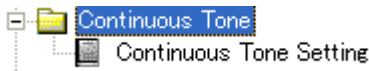

➤Continuous Tone

Select the desired CTCSS frequency from the list or enter a 3-digit DTCS code with polarity, N (Normal) or I (Inverse).

➤Continuous Tone Setting

Set the Continuous Tone Setting items for Tone Burst, CTCSS Reverse Burst Timer, etc.

Scan



➤Scan List

Set the scan type, primary CH, secondary CH, TX CH, Talkback CH, Cancel CH, and Text.

➤Scan setting

Set the Scan Setting items for Resume, Talkback, Fast Scan, Slow Scan, Power on scan etc.

Emergency



Enter up to a 24-character emergency text that will be displayed on the LCD while the emergency function is activated. Man Down, Lone Worker Timer can also be selected.

External I/O

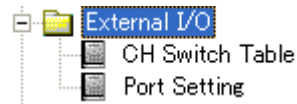

➤CH Switch Table

Available for mobile radios only.

➤Port Setting

The desired function can be assigned to some of the D-sub 25 pins on the screen.

The assignable pins are:

Ext. I/O [10]/[12]/[15]/[17]/[18]/[19]/[21]/[23]/[24] and [25].

Common



➤Key & Display

Assign the desired functions to the programmable function keys. And set the keypad operation, beep audio frequency, indication mode 1 line or 2 lines, etc.

➤Set Mode

User set mode enables you to customize the transceiver operation to suit your preferences and operation style.

➤Common

Commonly set items as Clone Comment, Security, Auto Reset, Scrambler, etc. items.

➤Character editor

Up to 16 original characters or symbols can be edited/created for a variety of information indication.

4-2-3 APCO P25 Trunking – Clone soft Setting

APCO P25 Trunking

This is the overall construction of the P25 Trunking System.

◇ Construction of P25 Trunking system

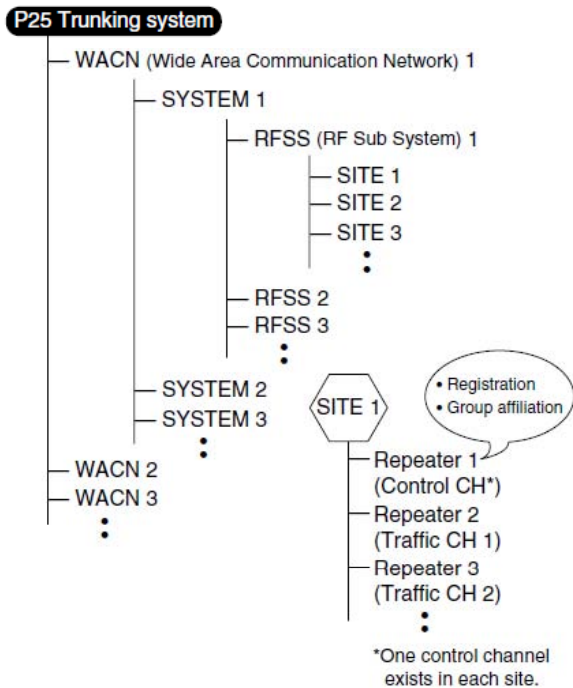

Following is the description on how to set up the P25 trunking functions in cloning software.

■ System Registration

➤ Home Setting

Home Setting			
System No.	Home Unit ID	Home WACN ID	Home System ID
1	000001	00001	001
New			

Home Unit ID

Enter the Unit ID component of the Subscriber Unit (SU) ID.

Home WACN ID

Enter the Wide Area Communications Network (WACN) ID component of the Subscriber Unit (SU) ID. The ID will be used to decide whether the radio should attempt to register on a confirmed control channel while the channel is selected.

When "SYSTEM" is selected for the **Coverage Type**, this Home WACN ID and Home System ID must match to those of a control channel to register for the channel.

If not, registration will not be performed and channel selection will continue to the next channel.

•Home System ID

Enter the System ID component of the Subscriber Unit (SU) ID for the system. The ID will be used to decide whether the radio should attempt to register on a confirmed control channel.

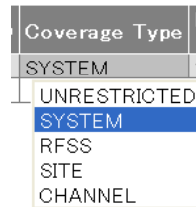

When "SYSTEM" is selected for the **Coverage Type**, this Home System ID and Home WACN ID must match to those of a control channel to register for the channel. If not, registration will not be performed and channel selection will continue to the next channel.

•**RFSS ID** Enter the RF Subsystem (RFSS) ID for the system.

When "SITE" or "RFSS" is selected for the **Coverage Type**, this RFSS ID and Site ID must match to those of a control channel to register for the channel. If not, registration will not be performed and channel selection will continue to the next channel.

•**Site ID** Enter the Site ID for the system.

When "SITE" is selected for the **Coverage Type**, this Site ID and RFSS ID must match to those of a control channel to register for the channel. If not, registration will not be performed and channel selection will continue to the next channel.

•Coverage Type

Select the coverage type for the area that the radio is allowed to roam from UNRESTRICTED, SYSTEM, RFSS, SITE and CHANNEL.

UNRESTRICTED	The roaming area is unrestricted for the radio.
SYSTEM	The Home WACN ID and the Home System ID need to match to the repeater.
RFSS	The Home WACN ID, Home System ID and RFSS ID need to match to the repeater.
SITE	The Home WACN ID, Home System ID, RFSS ID and Site ID need to match to the repeater.
CHANNEL	The Home WACN ID, Home System ID, RFSS ID and Site ID need to match to the repeater.

Trunking – System Registration (Left CH – 3)

System No.	Hunt List	Roaming List	CH ID List	Scan Timeout	Scan Threshold(dBm)	Mode Timeout
1	1 x	1 x	1 x	0.200	-114	2.000
New						

•Hunt List

Select the desired Hunt List from 1 to 4.

When the radio is powered on, changes trunking system, or goes out of range, the radio will find a control channel in a valid area with the hunt list. List control channels in the Hunt List screen.

When a hunt list with no valid channel is selected, "X" appears in the cell and "System Registration" in the tree view screen.

•Roaming List

Select the desired Roaming List from 1 to 4.

The radio will move to a system using the roaming list to find a channel that has higher quality, or provides better services. List roaming addresses in the Roaming List screen.

When a roaming list with no valid area is selected, "X" appears in the cell and "System Registration" in the tree view screen.

•CH ID List

Select the desired CH ID List from 1 to 4.

List channel identifiers in the CH ID List screen.

When a CH ID list with no valid channel is selected, "X" appears in the cell and "System Registration" in the tree view screen.

•**Scan Timeout** Enter the time period for the radio to scan a control channel while trying to detect a synchronized frame within the range of 0 to 60 sec (in 0.001 sec steps) The value should not be 0.

•Scan Threshold (dBm)

Set the minimum quality level for a control channel within the range of -120 to -70 (in 1 steps). When the Received Signal Strength Indication (RSSI) level is higher than this set level, the receiving signal is recognized as a control channel.

•**Mode Timeout** Enter the time period for the radio to scan a frequency while trying to get control channel information within the range of 0 to 60 sec (in 0.001 sec steps).

➤Background Scan Setting

Back Ground Scan Setting							
System No.	Mode Timeout	Enable	Interval (Sec)	Duration (Sec)	Trigger Enable	Hunt Threshold	Hunt Delta
1	2.000	Inhibit	8.000	0.200	Inhibit	-114	0
New							

Enable the background scan to monitor a control channel of the adjacent site while waiting to register a control channel. Select "Enable" to activate the function.

•**Interval (Sec)** (Available only when "Enable" is selected in **Enable** above)

Enter the interval time for background scan function within the range of 0 to 60 sec (in 0.001 sec steps). Interval determines how often the radio monitors a control channel of the adjacent site.

•**Duration (Sec)** (Available only when "Enable" is selected in **Enable** above)

Enter the duration of time for back ground scan function within the range of 0 to 60 sec (in 0.001 sec steps). The radio monitors the adjacent channel and checks whether there is a valid signal or not for up to this duration.

•Trigger Enable

This function activates the background scan only when the Received Signal Strength Indication (RSSI) level of a control channel becomes lower than the set level in **Hunt Threshold** and more than the number of times in **Hunt Delta** below. Select "Enable" to use the function.

•**Hunt Threshold** (Available only when "Enable" is selected in **Trigger Enable** above)

Enter the hunt threshold within the range of -120 to 70 (in 1 steps).

When the Received Signal Strength Indication (RSSI) level of a monitoring control channel is lower than this level and more than the number of times in **Hunt Delta** below, the radio activates the background scan and monitors a control channel of the adjacent site.

•**Hunt Delta** (Available only when "Enable" is selected in **Trigger Enable** above)

Enter the number of times for hunt delta within the range of 0 to 70 (in 1 steps).

When the Received Signal Strength Indication (RSSI) level of a monitoring control channel is lower than the set level in **Hunt Threshold** and more than this set times, the radio activates the back ground scan and monitors a control channel of the adjacent site.

Tx Power Level	FOACSU	Conversation Type
H	OFF	Message

•Tx Power Level

Select the initial transmit output power for the system from L1, L2 and H.

Output power can be manually toggled by [High/Low] if this function is assigned to a key in the Key & Display Assign screen.

Such manually selected output power setting can be either kept independently for each channel or shared in channels by the selection at **RF Power Selection** in the Key & Display Assign screen.

NOTE:

Do not assign [High/ Low] function if transmit power setting must not be changed by an operator.

L1: Low1	[High/Low] selects "Low1" only.
L2: Low2	[High/Low] toggles the output power between "Low1" and "Low2".
H : High	[High/Low] toggles the output power between "Low1", "Low2" and "High".

•FOACSU

Turn the Full Off Air Call Setup (FOACSU) function for trunking communication.

The function enables the radio to emit a beep when receiving a trunking mode call, and then ask for the user's permission to accept the call.

Select "OFF" not to emit a beep and accept the call without asking permission from the user.

NOTE:

You can set the audio frequency for the beep in **Beep-High 2 Freq (Hz)** in the Key & Display Assign screen.

•Conversation Type

Select the conversation type for trunking communication.

Message	The radio will allow transmissions while being in a traffic channel for talkgroup calls.
Transmission	The radio will not allow transmissions while being in a traffic channel for talkgroup calls.

■Hunt List

List Operation

•Capacity

Set the available number of channels for the Hunt. When "5" is entered in **Capacity** of Hunt List1, Hunt List1 has 5 channels. A total of 4 hunt list settings are available, and each list can have up to 64 channels.

Hunt List Operation		
Hunt List	Capacity	Used
1	0	0
2	0	0
3	0	0
4	0	0
Total	0	0
Left	256	256

•Hunt List

Trunking - Hunt List 1 (Left CH - 64)									
CH No.	Valid	RX	RX CH ID	RX CH Number	RX Freq	TX	TX CH ID	TX CH Number	TX Freq
New									

Even if the available number of control channels in a list has been set in Capacity in the List Operation screen, you can add or delete a channel in each list. To create a new channel, point to the cell on the [New] line which is located at the bottom of the screen, then double click or right click to display the Edit menu and click [Edit...Enter] to create a new channel.

•Valid

This function validates entry into the channel. Select "ON" to validate the entry.

•RX Select the way to set downlink frequencies of control channels.

CH ID Only	Set a downlink frequency of a control channel in RX CH ID and RX CH Number .
CH Freq Only	Set a downlink frequency of a control channel in RX Freq .

•RX CH ID Enter a control channel ID from broadcast channel structure to set a downlink frequency. The ID is defined by TIA TSB-102. AABD.

•RX CH Number

Enter a control channel number from the broadcast channel structure to set a downlink frequency. The number is defined by TIA TSB-102. AABD.

•RX Freq

Enter a downlink frequency of a control channel in Hertz (Hz).

NOTE:

The value must match to the value calculated from a channel broadcast.

•TX

Select the way to set uplink frequencies of control channels.

CH ID Only	Set an uplink frequency of control channel in TX CH ID and TX CH Number .
CH Freq Only	Set an uplink frequency of control channel in TX Freq .

•TX CH ID

Enter a control channel ID from the broadcast channel structure to set an uplink frequency. The ID is defined by TIA TSB-102. AABD.

•TX CH Number

Enter a control channel number from the broadcast channel structure to set an uplink frequency. The number is defined by TIA TSB-102. AABD.

•TX Freq

Enter an uplink frequency of a control channel in Hertz (Hz).

NOTE:

The value must match to the value calculated from a channel broadcast.

■Roaming List

•List Operation

Roaming List Operation		
Roaming List	Capacity	Used
1	0 : 0	0
2	0 : 0	0
3	0 : 0	0
4	0 : 0	0
Total	0	0
Left	40	40

•Capacity

Set the available number for the Roaming. When "5" is entered in **Capacity** of Roaming List1, Roaming List1 has 5 addresses. A total of 4 roaming list settings are available, and each list can have up to 10 addresses.

•List

Trunking - Roaming List 1 (Left CH - 10)				
List No.	Valid	WACN ID	SYSTEM ID	Home System
New				

Even if the available number of roaming areas in a list has been set in the **Capacity** item in the List Operation screen, you can add or delete an area in each list.

To create a new roaming area, point to the cell on the [New] line which is located at the bottom of the screen, then double click or right click to display the Edit menu and click [Edit...Enter] to create a new area.

•Valid

This function validates entry into the roaming area. Select "ON" to validate the entry.

•WACN ID

Enter the Wide Area Communications Network (WACN) ID component of the Subscriber Unit (SU) ID for the roaming area.

•SYSTEM ID Enter the System ID component of the Subscriber Unit (SU) ID for the roaming area.

•Home System This function determines the roaming area as the Home System. Select "ON" for the Home System.

■CH ID List

List Operation

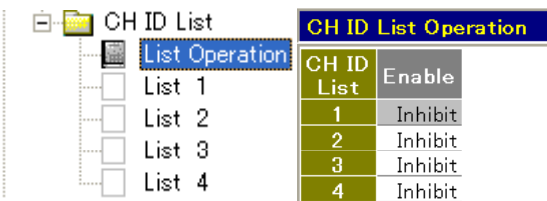

•Enable

This item determines valid CH ID Lists. Select "Enable" to validate the CH ID List. A total of 4 channel identifier list settings are available.

•List

Trunking - CH ID List 1					
List No.	Valid	Base Frequency (MHz)	Channel Spacing (kHz)	Tx Offset Sign	Tx Offset (MHz)
1- 1	---	---	---	---	---
1- 2	---	---	---	---	---
1- 3	---	---	---	---	---

•Valid

This function validates entry into the channel. Select "ON" to validate the entry.

•Base Frequency (MHz)

Enter the lowest channel frequency that starts from for the channel identifier. The frequency is used to calculate a frequency of a control channel.

•Channel Spacing (kHz)

Enter the channel spacing for each channel number.

•Tx Offset Sign

Select the Tx Offset Sign from - (Minus) and + (Plus) sign.

•Tx Offset (MHz)

Enter the transmit frequency offset from the receive frequency.

■ OTAR Setting

For details on how to set up the OTAR function in cloning software, please see the instructions below.

➤ CAI



List No.	Registration	Type	KMM Enc ON/OFF	CKR	MAC Derived Key
1	OFF	Unconfirmed	OFF	1	OFF
2	OFF	Unconfirmed	OFF	1	OFF
3	OFF	Unconfirmed	OFF	1	OFF
4	OFF	Unconfirmed	OFF	1	OFF

Registration

Select a way the radio performs registration and deregistration for a Key Management Facility (KMF) by transmitting Key Management Messages (KMMs).

OFF	The radio does not perform registration and deregistration for the KMF.
Standard	The radio transmits KMMs (Registration and Deregistration) to the KMF according to OTAR Registration Procedure/Deregistration Procedure. These procedures are defined by TIA-102. AACA, section 2.
Packet Data	The radio transmits KMMs (Registration and Deregistration) using packet data. The packet data is defined by TIA-102. BAAD, section 1.

Type

Select the packet frame type for Key Management Messages (KMMs) exchanged between the radio and a Key Management Facility (KMF).

Unconfirmed	The radio uses unconfirmed packets to exchange KMMs with the KMF. The radio transmits KMMs (Registration and Deregistration) to the KMF with Response Kind 1.
Confirmed	The radio uses confirmed packets to exchange KMMs with the KMF. The radio transmits KMMs (Registration and Deregistration) to the KMF with Response Kind 3.

KMM Enc ON/OFF

Select whether or not to encrypt Key Management Messages (KMMs).

OFF	Select whether or not to encrypt Key Management Messages (KMMs).
ON	The radio encrypts KMMs (Registration, Deregistration, Hello and Unable To Decrypt) using the Common Key Reference (CKR) programmed in CKR below.

CKR

Set the Common Key Reference (CKR) used for the system within the range of 1 to 4095. The CKR is used for encrypting Key Management Messages (KMMs-Registration, Deregistration, Hello and Unable To Decrypt). It is also used in the making of Message Authentication Code (MAC).

MAC Derived Key

Select whether or not to use the Derived MAC Key to make Message Authentication Codes (MACs).

OFF	The radio does not use the Derived MAC Key to make MACs.
ON	The radio uses the Derived MAC Key to make MACs.

NOTE:

When the programmed CKR is DES, the radio does not use the Derived MAC Key to make MACs even if "ON" is selected in the setting.

➤ SNDCP

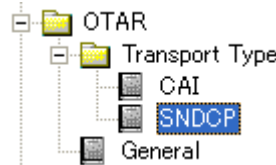

Registration

Select whether or not the radio performs registration and deregistration for a Key Management Facility (KMF) by transmitting Key Management Messages (KMMs).

OFF	The radio does not perform registration and deregistration for the KMF.
ON	The radio transmits KMMs (Registration and Deregistration) to the KMF according to OTAR Registration Procedure/Deregistration Procedure. These procedures are defined by TIA-102. AACA, section 2.

Type

Select the packet frame type for Key Management Messages (KMMs) exchanged between the radio and a Key Management Facility (KMF).

KMM Enc ON/OFF

Select whether or not to encrypt Key Management Messages (KMMs).

Unconfirmed	The radio uses unconfirmed packets to exchange KMMs with the KMF. The radio transmits KMMs (Registration and Deregistration) to the KMF with Response Kind 1.
Confirmed	The radio uses confirmed packets to exchange KMMs with the KMF. The radio transmits KMMs (Registration and Deregistration) to the KMF with Response Kind 3.

NOTE: When the programmed Common Key Reference (CKR) is Data Encryption Standard (DES), the radio does not use the Derived MAC Key to make MACs even if "ON" is selected in the setting.

KMF Setting

KMF IP Address

Enter the IP address of the Key Management Facility (KMF).

KMF UDP Port

Set the User Datagram Protocol (UDP) port of the Key Management Facility (KMF) within the range of 1 to 65535.

Subscriber Setting

Network Address Type

Select the type of the Network Address to be used for the system as defined by TIA-102. BAEB.

OFF	The radio does not use the Derived MAC Key to make MACs.
ON	The radio uses the Derived MAC Key to make MACs.

IP Address (Available when "IPv4 Static" is selected in **Network Address Type** above.)

Enter the IPv4 IP address for the system.

Net Mask (Available when "IPv4 Static" is selected in **Network Address Type** above.)

Enter the IPv4 network mask for the system.

Gateway Address (Available when "IPv4 Static" is selected in **Network Address Type** above.)

Enter the IPv4 gateway address for the system.

Subscriber OTAR Port

Set the User Datagram Protocol (UDP) port of the radio within the range of 1 to 65535.

IP Header Compression

Select whether or not to compress the IP Header for the system as defined by TIA-102. BAEB, section 6.2.4. When "ON" is selected, the IP Header is compressed as defined by RFC 1144.

TCP/IP State Slots (Available when "ON" is selected in **IP Header Compression** above.)

Enter the number of the TCP/IP Header to cache while compressing the IP Header for the system as defined by TIA-102. BAEB, section 6.2.5.

Valid values are 0 through 15, corresponding to 1 through 16 state slots respectively.

SNDTCP Version

Select the SNDTCP version to be used for the system as defined by TIA-102. BAEB.

Access Point Name (Available when "Ver.2" is selected in **SNDTCP Version** above.)

Enter the Access Point Name. When no Access Point Name is entered, it acts a wild card and matches any incoming connection.

IPv4 Static	Enables the static network configuration. The following settings, IP Address, Net Mask and Gateway Address must be programmed.
IPv4 Dynamic	Enables the dynamic network configuration.
No Address	Disables the address assignment.

OFF	The radio does not encrypt KMMs.
ON	The radio encrypts KMMs (Registration, Deregistration, Hello and Unable To Decrypt) using the Common Key Reference (CKR) programmed in CKR below.

➤ **General**

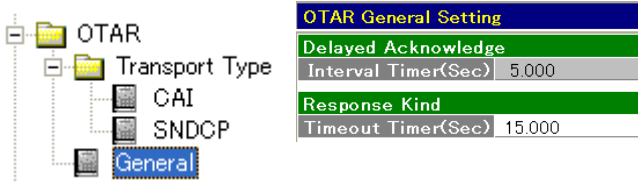

The screenshot shows the OTAR software configuration interface. On the left is a tree view with the following structure:

- OTAR
 - Transport Type
 - CAI
 - SNDOP
 - General** (selected)

On the right is a settings table:

OTAR General Setting	
Delayed Acknowledge	
Interval Timer(Sec)	5.000
Response Kind	
Timeout Timer(Sec)	15.000

Delayed Acknowledge

Interval Timer (Sec)

Enter the time period for Interval Timer within the range of 0.0 to 25.5 (in 0.1 sec steps). The radio delay transmitting acknowledgment for this set period after receiving a Key Management Message (KMM) that requests Delayed Acknowledgment. When transmitting more than one Delayed Acknowledgments, the radio transmits acknowledgment at these intervals.

Response Kind

Timeout Timer (Sec)

Enter the time period for Timeout Timer within the range of 0 to 255 (in 1 sec steps). The radio waits for response from a Key Management Facility (KMF) for this set period after transmitting a Key Management Message (KMM) with Response Kind 3.

The IC-F9510 series provides capability to set up your own talk groups and quiet stand-by when others are talking. You can also set up selective calls to individuals in P25 digital operation mode.

■ CTCSS or DTCS like operation

■ Memory CH > Zone

Zone 1: (Left CH - 496)			
P25 Conventional			
CH	RX NAC (Hex)	TX NAC (Hex)	Squelch Type
1- 1	FFF	000	NAC

➤ RX NAC

Set the desired receive NAC (Network Access Code) from 000 to FFF (hexadecimal code) to separate the transceiver from the same/adjacent channel station according to the assigned code.

The transceiver selectively accesses the one of several repeaters within overlapping coverage areas allowing the user to listen to a specific repeater.

NOTE:
"F7E" is a special code, and matches to any NAC.

➤ TX NAC

Set the desired transmit NAC (Network Access Code) from 000 to FFF (hexadecimal code) to separate the transceiver from the same/adjacent channel station according to the assigned code.

The transceiver selectively accesses one of several repeaters within overlapping coverage areas allowing the user to send to a specific repeater.

NOTE:
"F7E" and "F7F" are invalid.

➤ Squelch Type setting

NAC : The mute is released when the matched NAC is received even if the Individual ID or Talkgroup ID is not matched.

■ Selective Call operation

■ Individual Call

➤ Unit ID

Available transceiver's unit ID is 000001 to 98967F(hexadecimal code) or 1 to 9999999 (decimal code) to each channel.

Each ID can be set with up to a 12-character ID name.

□ Individual Call Option (Digital > Option)

■ ID-MR

When this function is turned ON, the received ID code is memorized.

■ EDIT ID

When this function is turned ON, the individual ID can be edited/changed via the 10-key operation. Individual ID must be within the Individual ID range, specified by Individual Encode ID Min and Individual Encode ID Max settings.

■ Unit ID Display on Receive

When this function is turned ON, the called station's individual ID number or name will be displayed on the LCD for 2 sec when receiving a matched individual ID.

■ Ringer on Receive

Select the desired ringer emission type when receiving a matched individual ID.

■ Group Call

➤ Talk Group ID

Available talkgroup ID is 0000 to FFFF (hexadecimal code) or 0 to 65535 (decimal code) .

Each ID can be set with up to a 12-character ID name.

NOTE:
FFFF (hex) or 65535 (dec) is used for the All Call.

■ Talk-group Option (Digital > Option)

■ Talkgroup Display on Mode Change or Receive.

The talkgroup ID number or name will be displayed on the LCD for a moment when the zone or channel is changed.

■ Talkgroup Display on Receive

The talkgroup ID number or name will be displayed on the LCD for 2 sec when receiving a matched talkgroup ID.

■ Unit ID Display on Receive

The called station's individual ID number or name will be displayed on the LCD for 2 sec when receiving a matched talkgroup ID.

■ Ringer on Receive

Select the desired ringer emission type when receiving a matched talkgroup ID.

■ Talkgroup Display on PTT

The talkgroup ID number or name will be displayed on the LCD for 2 sec when [PTT] is pushed.

➤ Squelch Type setting

Sel : The mute is released when the matched Unit ID or Talkgroup ID is received.

■ Scan List

A total of 17 scanning groups are available for a wide variety and flexible scanning operation. In this screen, program scanning condition for each group.

Channels included in the scan group [Zone] are scanned when the channels are in the same zone with the scan start channel.

NOTE:

Select channels to be included in the desired scan groups in **Scan List** in the Zone screen.

■ Display Text

Enter up to a 24-character text for easy recognition of the scan group.

The programmed texts are indicated in the scan selection mode.

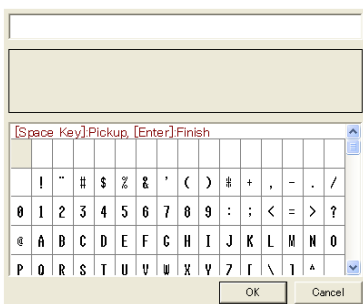

■ Scan Type

Set the scanning type to each scan group from **0) Scan OFF**, **2) Normal Scan** and **3) Priority Scan**. The watch time period, the power ON scan function etc. are programmable in the Scan Setting screen.

0) Scan OFF:

Scanning operation is turned OFF. If selected, the following scan settings are unavailable.

1) Normal Scan:

Normal scan. Scans all selected channels. The scan proceeds in sequence.

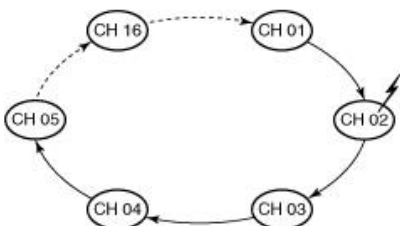

2) Priority Scan:

Priority scan. "Primary CH" and "Secondary CH" are used as the priority channels. Selected channels are scanned in sequence while monitoring "Primary CH" and "Secondary CH." When scan is paused on "Primary CH," other channels are not monitored.

NOTE:

"Prio A" stands for "Primary CH," and "Prio B" stands for "Secondary CH."

> When "Secondary CH" is not set:

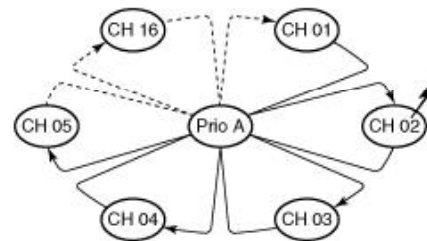

When a signal is detected on a channel other than "Primary CH," scan pauses until the signal disappears and "Primary CH" is continuously monitored. Scan moves and pauses on "Primary CH," if the signal is detected on "Primary CH".

> When "Secondary CH" is set:

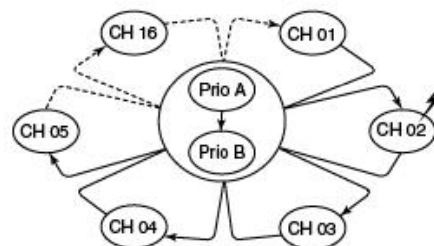

When a signal is detected on a channel other than "Primary CH" or "Secondary CH," scan pauses until the signal disappears and "Primary CH" and "Secondary CH" are continuously monitored alternately. Scan moves and pauses on either "Primary CH" or "Secondary CH," if the signal is detected on "Primary CH" or "Secondary CH".

> When a signal is detected on "Secondary CH," scan pauses until the signal disappears.

The compatibility of the previous and current scan mode:

The previous scan mode		The current scan mode					
		Scan Type	Primary CH	Secondary CH	TX CH	Talk Back	Cancel CH
Scan OFF		Scan OFF	-	-	-	-	-
Mode1	Normal	Normal	-	-	Last CH	-	TX CH
Mode1	R.SelA	Normal	-	-	Start CH	ON	Start CH
Mode2	Prio-A	Priority	Prio-A	-	Prio-A	ON	TX CH/TB
Mode2	Prio-A/B	Priority	Prio-A	Prio-B	Prio-A	ON	TX CH/TB
Mode2	R.Sel	Priority	Start CH	-	Start CH	ON	TX CH/TB
Mode2	R.SelA	Priority	Start CH	-	Start CH	ON	Start CH
Mode3	Prio-A	Priority	Prio-A	-	Prio-A	OFF	TX CH
Mode3	Prio-A/B	Priority	Prio-A	Prio-B	Prio-A	OFF	TX CH
Mode3	R.Sel	Priority	Start CH	-	Start CH	OFF	TX CH
Mode3	R.SelA	Priority	Start CH	-	Start CH	OFF	Start CH

Primary CH (Available when "Priority Scan" is selected in **Scan Type**) Select the desired channel as the primary channel. The selected channel is monitored during priority scan.

Prio-A CH	The priority A channel is used as the primary channel.
Prio-B CH	The priority B channel is used as the primary channel.
Start CH	The scan start channel is used as the primary channel.
R. Sel CH*	The selected channel by the rotary selector is used as the primary channel.
CH Number Select	The selected channel is used as the primary channel.

* R. Sel CH is available for only portable radios.

Secondary CH (Available when "Priority Scan" is selected in **Scan Type**) Select the desired channel as the secondary channel. The selected channel is monitored during priority scan. The secondary channel is lower priority than primary channel.

Disable	The secondary channel is not used.
Prio-A CH	The priority A channel is used as the secondary channel.
Prio-B CH	The priority B channel is used as the secondary channel.
Start CH	The scan start channel is used as the secondary channel.
R. Sel CH*	The selected channel by the rotary selector is used as the secondary channel.
CH Number Select	The selected channel is used as the secondary channel.

* R. Sel CH is available for only portable radios.

TX CH

Select the desired channel as the transmission channel.

Last CH	Transmission is performed in the channel that the scan stopped last. If it is no last channel, the scan start channel is selected for transmission.
Prio-A CH	Transmission is performed in the priority A channel.
Prio-B CH	Transmission is performed in the priority B channel.
Start CH	Transmission is performed in the scan start channel.
R. Sel CH*	Transmission is performed in the selected channel by the rotary selector.
CH Number Select	Transmission is performed in the selected channel.

* R. Sel CH is available for only portable radios.

Talk Back (Unavailable when "Last CH" is selected in TX CH)

Turn the talk back function for transmission ON or OFF. The function allows you to transmit a signal on the channel that the scan stopped last, when the transmission is performed during the scan stop the talk back timer* (after the resume timer has passed).

When "OFF" is selected, the channel selected in **TX CH** is always used for transmission.

* Talk back timer is set in **Talk Back (Sec)** in Scan Setting screen.

Cancel CH

Select the desired channel that is selected when the scan is cancelled (except for transmission).

Last CH	Scan is cancelled in the channel that the scan stopped last. If there is no last channel, the scan start channel is selected when the scan is canceled during scanning.
Prio-A CH	Scan is cancelled in the priority A channel.
Prio-B CH	Scan is cancelled in the priority B channel.
Start CH	Scan is cancelled in the scan start channel.
R. Sel CH*	Scan is cancelled in the selected channel by the rotary selector.
CH Number Select	Scan is cancelled in the selected channel.

Text

Select the text indication capability from Text or Start CH during scan. While the scan is pausing on a channel by receiving/transmitting a signal, the channel's text is indicated regardless of the setting.

Text	The text indication is turned ON. The channel's text that is programmed in Display Text as above is indicated during scan.
Start CH	The text indication is turned ON. The scan start channel's text is indicated during scan.

4-5 Display Text

■ Display Text

Enter up to a 24-character text for easy recognition of the scan group. The programmed texts are indicated in the scan selection mode.

■ Text-Portable

Right click to display the [Edit... Enter] menu and click [Edit... Enter].

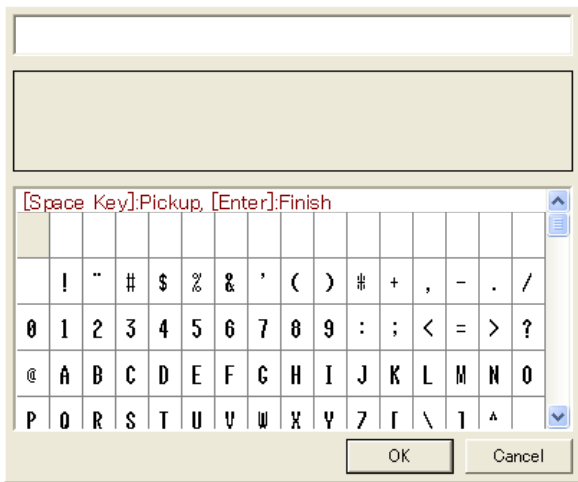

- Double click the desired character in the table or push [Space] to pick up the character.
- Push [Enter] to finish editing.

Usable characters are listed below.

	!	"	#	\$	%	&	'	()	*	+	,	-	.	/									
0	1	2	3	4	5	6	7	8	9	:	;	<	=	>	?									
@	A	B	C	D	E	F	G	H	I	J	K	L	M	N	O									
P	Q	R	S	T	U	V	W	X	Y	Z	[\]	^	_									
`	a	b	c	d	e	f	g	h	i	j	k	l	m	n	o									
p	q	r	s	t	u	v	w	x	y	z	{		}	~	ù									
Б	Г	Д	Ж	З	И	Й	К	Л	М	Н	О	П	Р	С	Т	У	Ф	Х	Ц	Ч	Ш	Щ	Ъ	Ы
■	i	¢	£	¤	¥	¦	§	¨	©	ª	«	¬	®	¯	°	±	²	³	´	µ	¶	·	¸	¹
°	±	²	³	´	µ	¶	·	¸	¹	º	»	¼	½	¾	¿									
À	Á	Â	Ã	Ä	Å	Æ	Ç	È	É	Ê	Ë	Ì	Í	Î	Ï									
Ð	Ñ	Ò	Ó	Ô	Õ	Ö	×	Ø	Ù	Ú	Û	Ü	Ý	Þ	ß									
à	á	â	ã	ä	å	æ	ç	è	é	ê	ë	ì	í	î	ï									
ø	ñ	ò	ó	ô	õ	ö	÷	ø	ù	ú	û	ü	ý	þ	ÿ									

- You can use and make an original character that is edited in the Character Editor Screen.

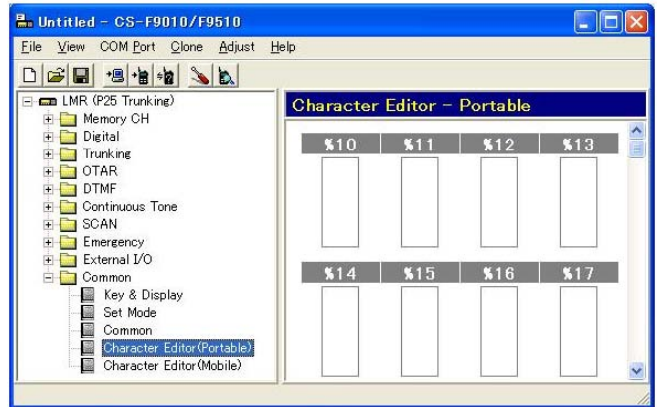

Edit the original character

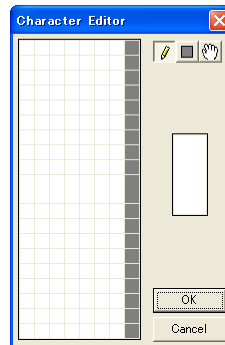

Up to 16 original characters or symbols can be edited/created in this sheet for a variety of information indication.

1. Right click to display the Edit menu.
2. Left click [Edit... Enter] then the Character Editor screen appears. Edit the squares with Left click on the desired square.

- Left click the square to change the square color white to black when or is selected.
- Right click the square to change the square color black to white when or is selected.
- When is selected, the square can be moved in all directions.

- changes the square color one pixel at a time.
- changes the square color of all pixels at once.

* Right click to display the [Edit... Enter] menu and select Copy, Paste, Up and Down.

* Double clicking the desired thumbnail (%10 to %1F) in the screen also enters the Character Editor screen.

■ Voice scrambling function

The optional voice scrambler unit provides high performance private communication between stations with the same scrambler code. The IC-F9011 series has a built-in inversion type voice scrambler. (Analog mode only)

➤ What is 'Inversion type voice scrambler' ?

The audio frequency band is inverted as below. The frequencies in each band are inverted. The divided frequency is programmable with cloning.

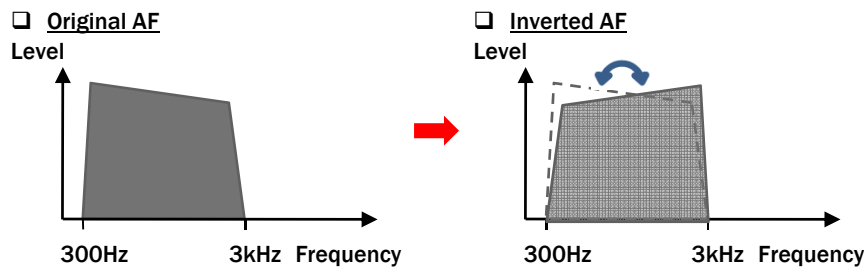

■ Optional AES/DES encryption



The IC-F9011 series provides AES and/or DES encryption for secure conversation with the optional **UT-125 AES/DES encryption unit** or **UT-128 DES encryption unit**. Versions certified to FIPS 140-2 Level 1 for AES encryption are planned for future release.



UT-125
AES/DES
Encryption Unit



UT-128
DES
Encryption Unit

- The **AES** (Advanced Encryption Standard) is a block cipher adopted as an encryption standard by the Federal Information Processing Standard (FIPS) for the United States in 2002. AES is based upon the Rijndael algorithm. AES offers 256-bit encryption.
- The **DES** (Data Encryption Standard) is a cipher selected as an official Federal Information Processing Standard (FIPS) for the United States in 1976. DES was developed by IBM and was based upon IBM's earlier Lucifer cipher. DES utilizes a 56-bit key. This key size is vulnerable to a brute force attack using current technology. In recent years, the cipher has been superseded by the AES.

NOTE : For details on how to activate AES/DES Encryption, please refer to the following page. The FIPS version will be available in the future. The FIPS (Federal Information Processing Standard) 140 are U.S. Government security standards that specify requirements for encryption modules and defines four levels of security, named Level 1 to Level 4.

❑ Activating Encryption

P25 radios have the ability to use DES or AES encryption. To enable encryption, you will need a **CKR (Common Key Reference)**. The KVL 3000 Plus keyloader from Motorola creates this key.

➤ Obtaining a CKR from the KVL 3000 Plus Keyloader

The following operation is for AES and DES upgraded radios. A newly upgraded radio will not encrypt/de-encrypt until you load a new CKR (also known as TEK—Traffic Encryption Key) to the radio.

Important: Not all KVL 3000 Plus keyloaders work with APCO P25 encryption. When the keyloader is powered up, the display will show **ASTRO ® 25** if it can be used for P25 encryption.

➤ Entering a New CKR (TEK) into the KVL

1. Using the soft keys just below the display in the KVL, select the following in sequence:
 - Keys
 - New
2. Enter the new key (CKR). This will be 5 numbers: "0" and any number between zero and 4095 (ex: 03456).
3. Press Enter.
4. Choose the algorithm AES or DES using the left right arrows (◀ or ▶), if the KVL is enabled for both algorithms. Otherwise, proceed to step 6.
5. Press the soft key to **Accept**.
6. Create a key ID by entering 4 identifying numbers from the keypad. This number is for dealer reference only.
7. Press Enter.
8. At the "Byte" prompt, enter a random set of numbers until the display shows **SLOT FILLED**. This may take from 30 to 60 numbers depending on the algorithm.

9. Press Enter. This CKR (TEK) is now stored in the KVL and can be loaded into the radio using the loading instructions detailed below.
10. Press Escape on KVL.

➤ Loading a Pre-loaded Key into your Radio

1. Connect your radio to the KVL with OPC-1534 and OPC-1871

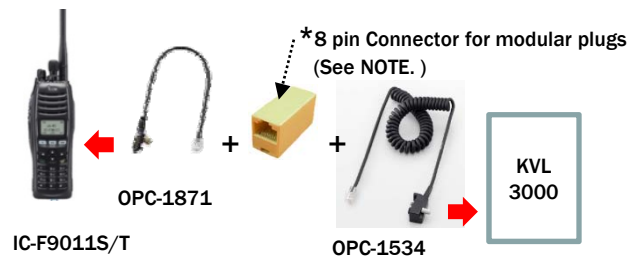

***NOTE :** Icom part No. 561000270 ALA651B Using this Icom connector is recommended but any other maker's connectors are also available. Please choose "straight type".

2. On the radio, press and hold P0 and P1, and then power up the radio. The display shows **KEY WAITING**.
3. Using the soft keys just below the display in the KVL, select the following in sequence:
 - Target
 - Load
 - Key
4. Using the left/right arrows (◀ or ▶), select the preprogrammed CKR (TEK).
5. After the proper CKR is on the KVL Screen, press the soft **LOAD** key. The radio display flashes until loading is complete. The radio will accept as many as 16 CKR numbers.

➤ Programming the Radio Cloning Software

1. Connect your radio to a computer with OPC-1862.
2. Open your cloning software and read the radio.
3. In **Memory CH » Encryption**, select **TX/RX**.
4. In **Memory CH » Encryption**, enter the CKR (TEK) that was loaded in the KVL.
5. In **Digital » Option**, ensure that the **Preamble Length** is 0~255. 120 is recommended.
6. In **Common » Key & Display**, assign a programmable button for **Encryption**.

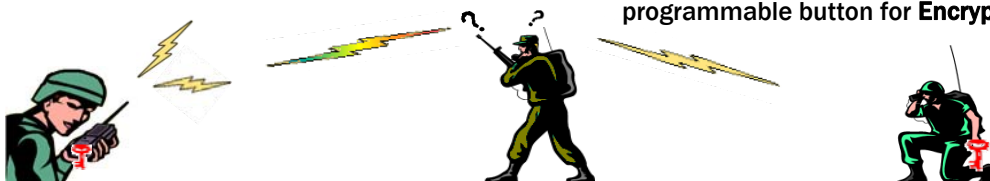

■What is OTAR ?

OTAR or Over-The-Air-Rekeying is the common name for the method of changing the encryption keys over a radio channel or “over the air”. It is also referred to as Over-the-Air Transfer (OTAT).

Regular key changing is one of the basic requirements for secure radio communication. Key changing can be achieved by reprogramming of scramblers with a wired programmer or over the air.

Presently radio communication systems, secured by scramblers, prefer to use the OTAR method of key changing due to the following benefits.

■Benefits from using OTAR

Brisk and efficient – these are the words to describe the benefits from using OTAR.

- The operator can change over the keys of many radios at the same time regardless of the distance.
- The keys which are consisted of big numbers can be easily changed or updated without manual programming.
- The use of OTAR drastically reduces the distribution of physical keying material and the physical process of loading crypto equipments with key, therefore it can save cost. A station has nothing to do with actual physical CRYPTO changeovers on a day-to-day basis.

Without OTAR, the operator has to collect all radios and reprogram them to change the keys. Or a technician must go around and visit all the radio sites with a PC and a programmer just to change keys – it is time-consuming.

In addition, without OTAR, it is very difficult or even impossible to re-program the scramblers with a wired programmer due to their big number and distances of one from another.

OTAR solves all these problems - you can do without reprogramming all the radios and visiting the radio sites. You can easily and briskly update the keys or change them over completely regardless of the distance and big numbers.

To make the most of these benefits, leading manufacturers of scramblers began to design various methods of key changing over the air. Many of the newer NSA (National Security Agency) cryptosystems that use the 128-bit electronic key, such as the ANDVT, KY-58, KG-84 A/C, and KY-75 are capable of obtaining new or updated key by OTAR. All an operator would have to do is to observe the alarm indications and ensure the alarm indicator returns to operate. The electronic key would normally come from the Net Control Station (NCS).

The current IC-F9011 series all include the OTAR function. (OTAR function became available from the firmware Rev.1.40 on.)

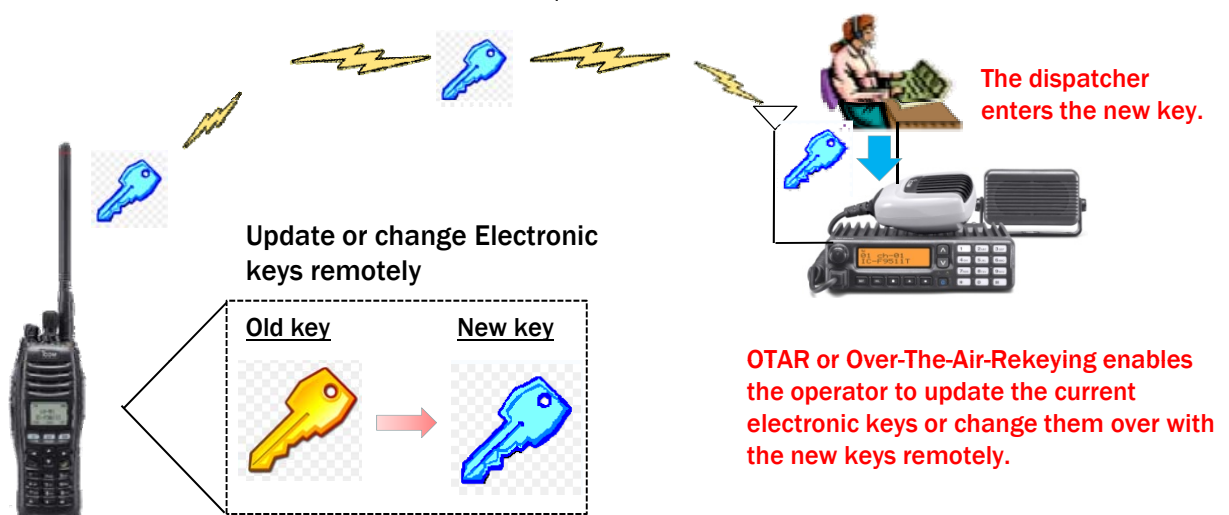

OTAR or Over-The-Air-Rekeying enables the operator to update the current electronic keys or change them over with the new keys remotely.

■ IC-F9510 series has DVSI AMBE +2™ New Vocoder Ready

Digital Voice Systems, Inc. specializes in low rate, high-quality voice compression products for use in digital communications and storage applications. Their products include vocoders, error correction schemes, test sets, and other offerings. DVSI is a leading provider of hardware and software voice coding solutions to equipment manufacturers and OEMs throughout the world.

DVSI has introduced a new low data rate AMBE+2™ Vocoder that sets a new standard for high-quality, high-performance speech quality at data rates from 2.0 to 9.6 kbps.

The new vocoder technology has been shown to outperform DVSI's previously industry-leading AMBE+™ Vocoder, that outperformed G.729 and G.726 vocoders while operating at only 4.0 kbps, and DVSI's baseline AMBE™ vocoder technology. It is designed to be particularly robust and perform exceptionally well even under bit errors and acoustic background noise conditions.

Recent independent evaluations have proved that the model-based, Multi-Band Excitation algorithm provides distinct advantages over traditional CELP-based vocoders. Operating at data rates from 2.0 to 9.6 kbps, the new AMBE+2™ algorithm has achieved higher Mean Opinion Scores (MOS) than any other vocoder technology tested.

The superior performance characteristics of the new AMBE+2™ Vocoder make it ideally suited for mobile radio, secure voice, satellite communications, computer telephony, and other digital voice and storage applications where bandwidth is at a premium and low data rate, high-quality is imperative.

The new AMBE+2™ Vocoder clearly illustrates why DVSI has been selected for many prominent global mobile satellite systems including: Inmarsat M and Mini-M, Iridium, ICO-Global, Thuraya, ACeS, and many others. DVSI was also chosen as the vocoder standard for the North American, APCO Project 25 public safety mobile radio system.

■ The Mean Opinion Score Values

In multimedia using codecs to compress the bandwidth requirement (for example, of a digitized voice connection from the standard 64 kilobit/sec PCM Modulation), the **Mean Opinion Score (MOS)** provides a numerical indication of the perceived quality of received media after compression and/or transmission. The MOS is expressed as a single number in the range 1 to 5, where 1 is lowest perceived audio quality, and 5 is the highest perceived audio quality measurement. Here is the AMBE+2™ MOS test result.

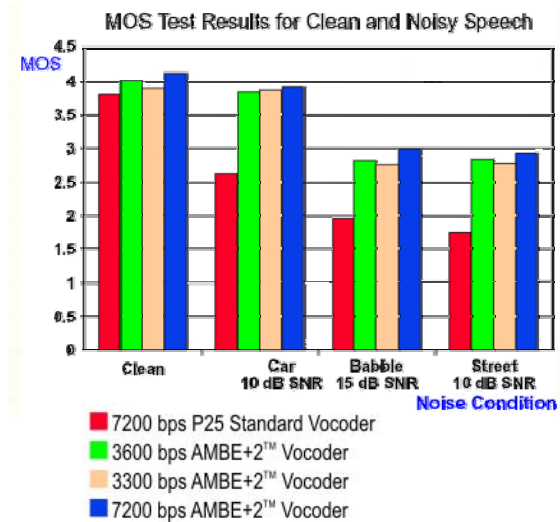

The vocoder speed specified by P25 specification slowed down from 7200 bps to 3200 bps but DVSI introduced a new enhanced vocoder of AMBE+2™ and prevented the deterioration of the sound quality. Please see the graph above. Even in 3600 bps, the AMBE+2™ is better than the P25 standard vocoder.

■ How Are MOS Tests Conducted?

MOS tests for voice are specified by ITU-T recommendation P.800. The MOS is generated by averaging the results of a set of standard, subjective tests where a number of listeners rate the heard audio quality of test sentences read aloud by both male and female speakers over the communications medium being tested. A listener is required to give each sentence a rating using the following rating scheme:

MOS	Quality	Impairment
5	Excellent	Imperceptible
4	Good	Perceptible but not annoying
3	Fair	Slightly annoying
2	Poor	Annoying
1	Bad	Very annoying

The information about the APCO P25 and IC-F9511 series is also available on the Icom America Inc. home page. Please browse <http://www.icomamerica.com/en/default.aspx>



Icom Global Site

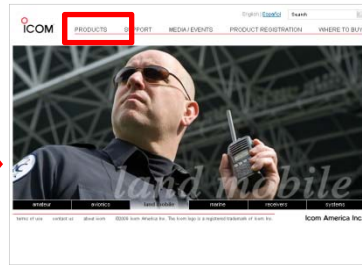

Icom America Inc. Home page

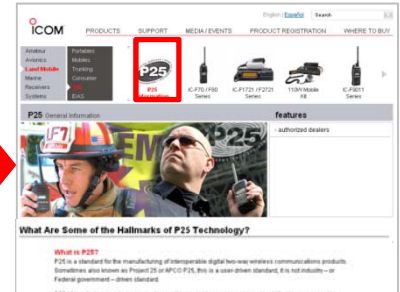

For more detailed information on P25

Information created by Icom America:

- [P25 Information Center](#) ①
- [P25 Radios at a Glance](#) ②

Independent P25 resources

- [Project25](#) ③
- [APCO International](#)
- [SAFECOM](#)

Following materials are downloadable from these sites. Please click here to get more detailed information on P25.

Basic information about P25

① P25 Information Center

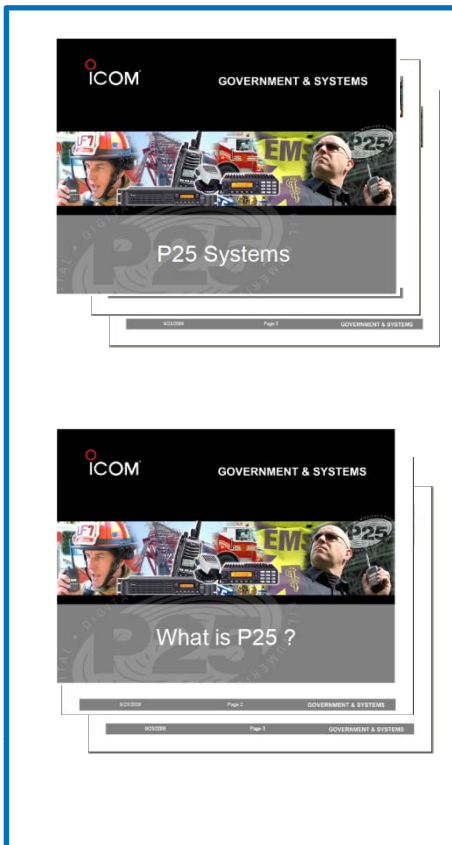

② P25 Radios at a Glance

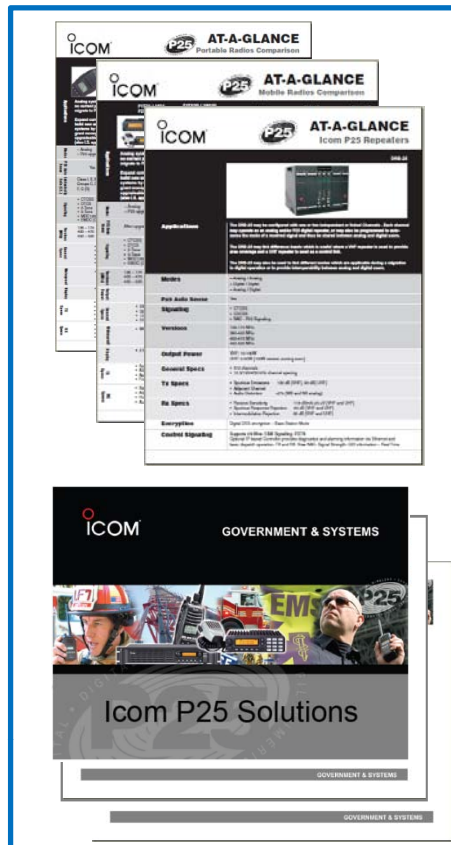

③ Project 25 Web site etc.



The information about the APCO P25 and IC-F9511 series are also available on the Icom America Inc. home page. Please browse <http://www.icomamerica.com/en/default.aspx>



Icom Global Site

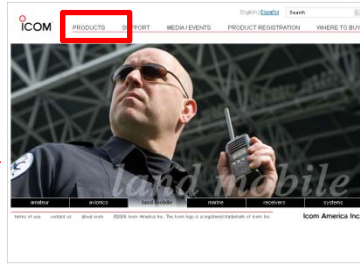

Icom America Inc. Home page

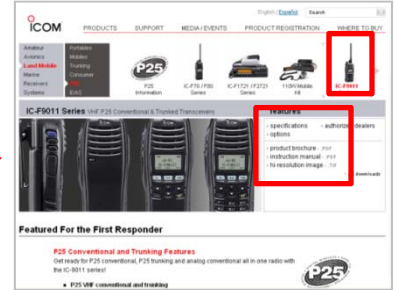

Land Mobile > IC-F9011 series

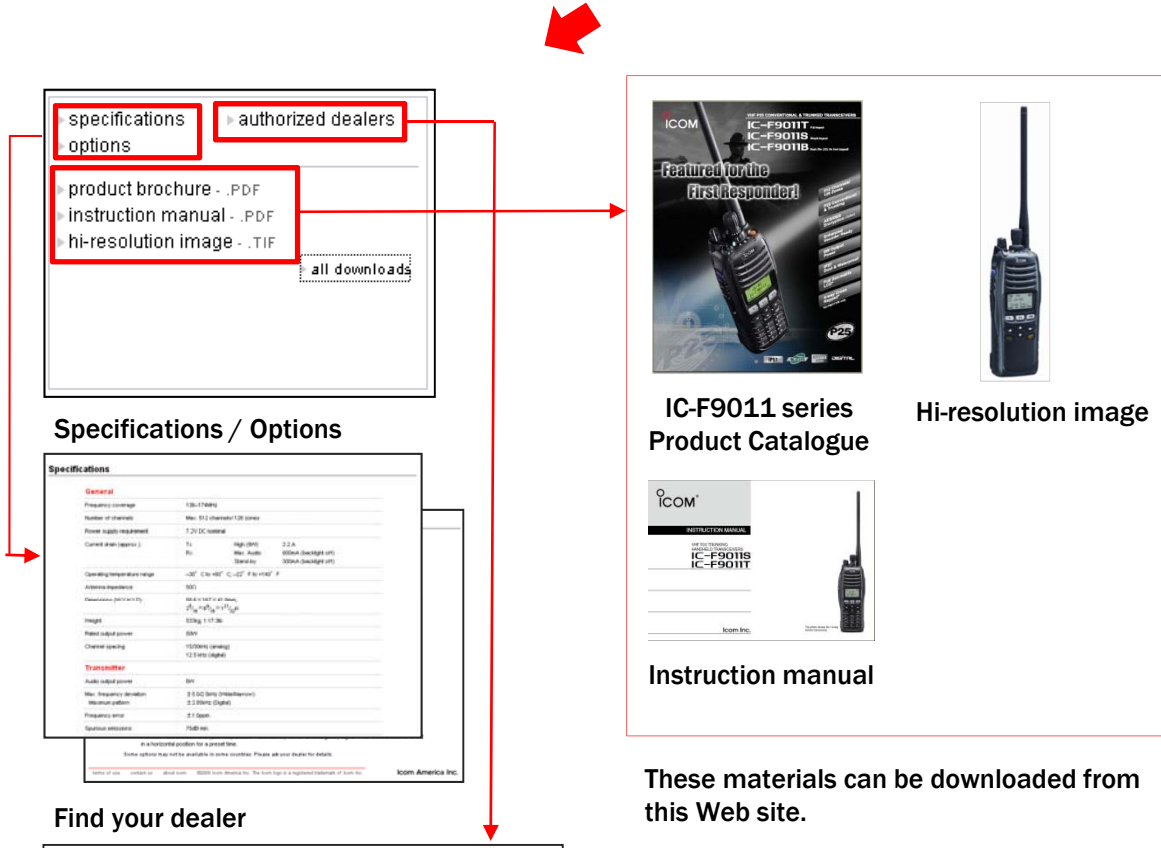

specifications options

authorized dealers

product brochure - .PDF

instruction manual - .PDF

hi-resolution image - .TIF

all downloads

Specifications / Options

Specifications	
External	
Frequency coverage	136-174MHz
Number of channels	Max. 312 channels (128 active)
Power supply requirement	1.2V DC nominal
Current drain (approx.)	Tx: High (9W) 2.2A Rx: Max. Audio 500mA (average only) Standby 100mA (average only)
Operating temperature range	-20° C to +60° C, -22° F to +140° F
Antenna impedance	50Ω
Antenna (recommended)	1/2 wave whip antenna
Weight	130g (4.6 oz)
Rated output power	9W
Channel spacing	12.5kHz (digital) 12.5kHz (analog)
Transmitter	
Auto output power	9W
Max. frequency deviation	± 3.0kHz (3rd Intermodulation)
Maximum modulation	± 3.0kHz (digital)
Frequency error	± 1.0ppm
Spurious emissions	70dBc

In a restricted position for a restricted time. Some options may not be available in some countries. Please ask your dealer for details.

Find your dealer

Locate a Dealer

Fill in the form below to locate an Icom America dealer near you.

Zip Code:

Search Radius: 25 Miles

Remember my search criteria

Products:

Amateur Avionics

Consumer Electronics Land Mobile

Marine Receivers

These materials can be downloaded from this Web site.

This site is helpful to find your nearby dealer dealing with the P25 transceivers

- The following Instruction Manuals are available on the Icom Web site.
Please browse <http://www.icom.co.jp/world/index.html>

< Home Page >

< Support Center Page >

Instruction Manual for :
IC-F9011B/S/T
IC-F9021B/S/T
IC-F9023B/S/T

Operating Guide for :
IC-F9011B/S/T
IC-F9021B/S/T
IC-F9023B/S/T

- The following Materials are available upon request through local Icom Distributors in your region.

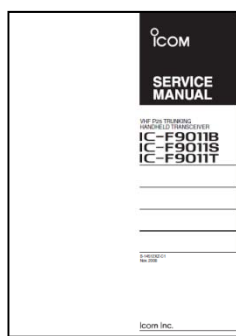

Service Manual for :
IC-F9011 B/S/T

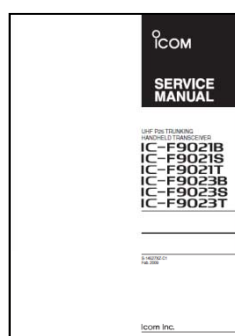

Service Manual for :
IC-F9021B/S/T
IC-F9023B/S/T

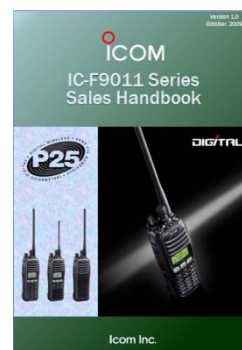

Sales Handbook



IC-F9011 RadioG uide

Icom America Inc.

For People Who Make Smart Choices

2380 116th Avenue NE
Bellevue, WA 98004
phone: 425-454-8155
fax: 425-454-1509
www.icomamerica.com

